

FUJIFILM

Surveillance Camera

FUJIFILM SX400

V1.1

Owner's Manual

FUJIFILM Corporation

BL00005458-202

Table of Contents

Safety Precautions	viii
For Your Safety	viii
⚠ WARNINGS	viii
⚠ CAUTIONS.....	viii
⚠ High-Temperature Warnings	viii
General Precautions.....	viii
NOTICES	ix
Caution:.....	ix
FCC Warning:.....	ix
For Customers In Canada	ix
About the Icons.....	ix
Disposal of Electrical and Electronic Equipment in Private Households In the European Union, Norway, Iceland and Liechtenstein:.....	ix
Precautions for Use	x
Operating Environment	x
Installation	x
Use	x
Network Connections	x
Introduction	1
Parts of the Camera	1
The Control Panel.....	1
Operating Mode Selection: DIP Switches	2
Eight-Pin Connector Pinout	2
Installation and Connection	3
Installation	3
Screw Hole Specifications.....	3
Internet Protocol (IP) Connections	4
Connection Schematic	4
Connecting to a Computer.....	4
Camera Controls.....	5
Stand-Alone Connections	6
Connection Schematic	6
Connecting to a Monitor	6

IP Connections—Viewing and Recording the Live Feed	8
Launching a Web Browser	8
IP Connections—Preferences	9
CAMERA SETTING	10
FOCUS	10
FOCUS AREA	10
IRIS	10
SHUTTER SPEED	10
GAIN	10
DAY/NIGHT	11
EXTERNAL TRIGGER	11
IR WAVELENGTH	12
IMAGE STABILIZATION	12
OPTICAL FILTER(DAY)	12
OPTICAL FILTER(NIGHT)	12
IMAGE QUALITY SETTING	14
WDR	14
BACKLIGHT CORRECTION	14
HEAT HAZE REDUCTION	14
FOG REDUCTION	14
NOISE REDUCTION	14
DIGITAL ZOOM	14
DIGITAL ZOOM RATIO	14
USE SETTING	15
BRIGHTNESS	15
CONTRAST	15
SATURATION	15
SHARPNESS	15
WHITE BALANCE	15
SYSTEM	16
MODEL NAME	16
SERIAL NO.	16
FW VER. (CAMERA)	16
FW VER. (SYSTEM)	16
FW VER. (LENS)	16
APPLICATION VER.	16
TIME ZONE	16
NTP SERVER ADDRESS	16
PORT NUMBER	16
CHECKING INTERVAL	16
PRIORITY OF TIME SETTING	17
IN-CAMERA TIME SETTING	17
ABOUT DEVICE	17

Table of Contents

PTZ SETTING	18
RS485 BAUD RATE.....	18
RS485 ID.....	18
RS485 TERMINATION.....	18
PTZ POSITION INQUIRY.....	18
Pelco-P/Pelco-D.....	18
PELCO CMD INTERVAL.....	18
PAN TILT SPEED CONTROL.....	18
PAN/TILT WITH OIS & EIS.....	18
SYSTEM MAINTENANCE	19
REBOOT.....	19
RESET SETTINGS.....	19
IMPORT CONFIGURATION FILE.....	19
EXPORT TO CONFIGURATION FILE.....	19
FIRMWARE UPDATE.....	19
COPY LOG DATA.....	19
CHANGE PASSWORD.....	19
SECURITY	20
RTSP AUTHENTICATION.....	20
RTSP AUTHENTICATION ALGORITHM.....	20
HTTP AUTHENTICATION.....	20
NETWORK SETTING	21
IPv4 ADDRESS.....	21
IPv4 SUBNET MASK.....	21
IPv4 DEFAULT GATEWAY.....	21
MAC ADDRESS.....	21
IPv4 MTU.....	21
PREFERRED DNS SERVER.....	21
ALTERNATE DNS SERVER.....	21
IPv4 ADDRESS.....	21
PORT	22
HTTP PORT.....	22
RTSP PORT.....	22
VIDEO	23
VIDEO FORMAT.....	23
ENCODING TYPE.....	23
BIT RATE TYPE.....	23
FRAME RATE.....	23
BIT RATE.....	23
I FRAME INTERVAL.....	23

DISPLAY/OSD SETTING	24
DAY & TIME DISPLAY	24
ID DISPLAY.....	24
ID (CAMERA NAME).....	24
TITLE DISPLAY.....	24
EDIT TITLE.....	24
TIME DISPLAY	24
DATE DISPLAY FORMAT	24
言語/LANG	25
言語/LANG.....	25
Defaults	26
CAMERA SETTING.....	26
IMAGE QUALITY SETTING	26
SYSTEM.....	26
PTZ SETTING	26
SYSTEM MAINTENANCE.....	26
SECURITY.....	27
NETWORK SETTING.....	27
PORT	27
VIDEO	27
DISPLAY/OSD SETTING.....	27
言語/LANG.....	27



Stand-Alone Connections—Camera Controls	28
Stand-Alone Connections—Camera Menus	29
Using the Menus	29
SHOOTING MENU 1	31
FOCUS	31
FOCUS AREA	31
IRIS	31
SHUTTER SPEED	31
GAIN	32
DAY/NIGHT	32
EXTERNAL TRIGGER	33
SHOOTING MENU 2	34
IR WAVELENGTH	34
IMAGE STABILIZATION	34
OPTICAL FILTER(DAY)	35
OPTICAL FILTER(NIGHT)	35
SHOOTING MENU 3	36
WDR	36
BACKLIGHT CORRECTION	36
HEAT HAZE REDUCTION	36
FOG REDUCTION	36
NOISE REDUCTION	36
DIGITAL ZOOM	36
DIGITAL ZOOM RATIO	36
SHOOTING MENU 4	37
USE SETTING	37
BRIGHTNESS	37
CONTRAST	37
SATURATION	37
SHARPNESS	37
WHITE BALANCE	37

SET-UP 1	38
DAY & TIME DISPLAY	38
TITLE DISPLAY.....	38
EDIT TITLE.....	38
ID DISPLAY.....	38
ID (CAMERA NAME).....	38
SET DATE & TIME.....	38
SET-UP 2	39
VIDEO SYSTEM.....	39
VIDEO FORMAT.....	39
ASPECT FOR VIDEO.....	39
RS485 ID	39
RS485 BAUD RATE.....	39
RS485 TERMINATION.....	39
PROTOCOL	39
SET-UP 3	40
SD CARD OVERWRITE.....	40
FORMAT SD CARD	40
IP ADDRESS INFORMATION	40
FIRMWARE	40
COPY LOG DATA	41
RESET.....	41
言語/LANG.....	41
Defaults	42
SHOOTING MENU	42
SET-UP.....	42
Troubleshooting	43
Specifications	44
License	45
AVC patent portfolio license	45

Safety Precautions

For Your Safety

This section lists important precautions that must be followed to ensure safe and correct use of the product. Read them before using the product and observe them during use.

The  **WARNING** and  **CAUTION** indications in this document indicate the following:

 **WARNINGS** Failure to observe warnings could result in death or serious injury.

 **CAUTIONS** Failure to observe cautions could result in injury or property damage.

WARNINGS

- Take all steps necessary to prevent water entering the product. Failure to observe this precaution could result in fire or electric shock. Should water find its way in, disconnect the power source immediately.
- Be sure the product is installed securely. Serious accidents could result should the product fall from a height.
- When working in high places, work with a partner or partners, use a safety line, and take all other precautions necessary to ensure safety. Slipping, falling, or loss of balance could result in serious accidents.
- When installing the camera in high places, ensure that people below keep their distance. Falling objects could cause serious accidents.
- Ensure that the surface on which the camera is installed is level. Failure to observe this precaution could cause the camera to fall, potentially causing serious accidents.

CAUTIONS

- Keep the product out of direct sunlight.
- Do not turn the product on without first confirming that the power supply is connected correctly.
- The product could cause injury if dropped during transport. Take all precautions necessary to ensure that the product is not dropped.
- Ensure that the voltage of the power supply matches the product's rated voltage. Incorrect voltages could damage the product or result in fire or electric shock.
- When connecting or disconnecting the power cable, hold the plug and not the cable. Damage to the cable could result in fire or electric shock.
- Should you detect any abnormalities such as smoke, unusual noises or smells, or the presence of foreign matter inside the product, disconnect the power supply immediately and contact the original retailer.
- Do not disassemble or modify. Failure to observe this precaution could result in electric shock or product malfunction. Malfunctions or damage resulting from customers disassembling or modifying the product are not covered under warranty.
- Do not aim the camera at the sun. Direct sunlight focused through the lens could damage the product's internal parts.
- Install the camera base down. Installing the camera in other orientations could lead to warping that may impair product performance.
- Any memory cards used must meet the standards for SD (Secure Digital) memory cards.

High-Temperature Warnings

- Metal parts could cause burns when the ambient temperature is elevated. Before touching these parts, switch the equipment off and wait at least 30 minutes.

General Precautions

- Do not apply force to the connectors when handling the product. Failure to observe this precaution could result in the product being disconnected or damaged.
- Use the product only as described in this manual.
- The camera and its accessories are precision devices. Under no circumstances should they be subjected to excessive force.
- Install the camera in a housing or other location where it will not be exposed to rain, wind, dust, or direct sunlight.
- Bringing the camera abruptly from a cold location to a warm and humid environment could cause the lens to fog. Take measures to allow the camera to adapt to the new environment before subjecting it to changes in temperature and humidity.
- Replace the cap if the camera will not be used for an extended period.
- The camera lens has a special anti-reflective coating. As a result, the back of the lens may appear spotted, but this has no effect on performance.

NOTICES

Verification

Model Number: SX400

Trade Mark: Fujifilm

This device complies with Part 15 of the FCC Rules.

Operation is subject to the following two conditions:

(1) This device may not cause harmful interference, and (2) this device must accept any interference received, including interference that may cause undesired operation.

Caution:

This equipment has been tested and found to comply with the limits for a Class A digital device, pursuant to part 15 of the FCC Rules.

These limits are designed to provide reasonable protection against harmful interference when the equipment is operated in a commercial environment.

This equipment generates, uses, and can radiate radio frequency energy and, if not installed and used in accordance with the instruction manual, may cause harmful interference to radio communications. Operation of this equipment in a residential area is likely to cause harmful interference in which case the user will be required to correct the interference at his own expense.

FCC Warning:

To assure continued compliance, follow the attached installation instructions. This includes using the provided power cord and shielded interface cables when connecting to computer or peripheral devices. Also, any unauthorized changes or modifications to this equipment could void the user's authority to operate this device.

For Customers In Canada

CAN ICES(A)/NMB(A)

WARNING: This equipment is compliant with Class A of CISPR32. In a residential environment this equipment may cause radio interference.

This product complies with the following EU Directives:

- RoHS Directive 2011/65/EU
- EMC Directive 2014/30/EU

Compliance with these directives implies conformity to applicable harmonized European standards (European Norms) which are listed on the EU Declaration of Conformity issued by FUJIFILM Corporation for this product or product family.



This compliance is indicated by the following conformity marking placed on the product:



This marking is valid for non-Telecom products and EU harmonized Telecom products (e.g. Bluetooth).

About the Icons

The symbols on the product represent the following:

	AC
	DC
	Class II equipment (The construction of the product is double-insulated.)

Disposal of Electrical and Electronic Equipment in Private Households In the European Union, Norway, Iceland and Liechtenstein:

This symbol on the product, or in the manual and in the warranty, and/or on its packaging indicates that this product shall not be treated as household waste. Instead it should be taken to an applicable collection point for the recycling of electrical and electronic equipment. By ensuring this product is disposed of correctly, you will help prevent potential negative consequences to the environment and human health, which could otherwise be caused by inappropriate waste handling of this product.



Precautions for Use

Operating Environment

- The camera can be used at temperatures of from –10 to +50 °C (temperatures below freezing are only supported if the power supply is not interrupted) and at humidities of from 10 to 80% (no condensation).
- Prolonged use at high temperatures or humidities could degrade components, shortening product life.
- Do not install the product where it will be exposed to solvents or other chemicals.

Installation

- Do not install LAN or audio cables in close proximity to cables for fluorescent lights or other electrical devices. Failure to observe this precaution could impair sound or image quality. Move the cables if signal quality is affected.
- Using the product in close proximity to powerful electromagnetic fields, such as those produced by television transmitter antennas, electric motors, or transformers, could result in distorted or wavy pictures. Should this occur, use steel cable shielding.
- Use a Category 5 or better shielded twisted pair (STP) LAN cable for LAN connections.
- Plastic cable insulation may sometimes be damaged by crows or other birds. Protect cables using a cable conduit.
- Fix cables in place so that they are not subject to repeated vibration, friction, or tugging. Failure to observe this precaution could cause the cable to break.
- Install the product base down.

Use

- Do not aim the lens directly at the sun or other bright light sources or reflections. Failure to observe this precaution could result in deterioration of the image sensor color filter, affecting picture color.
- Do not subject the product to strong physical shocks or vibration. Failure to observe this precaution could result in product malfunction.
- Clean the product with a soft, dry cloth. Never use chemically-treated cloths or solvents such as benzine (petroleum ether), thinner, or alcohol. Failure to observe this precaution could cause warping or discoloration.
- Do not apply force to the connectors when handling the product. Failure to observe this precaution could result in the product being disconnected or damaged.

Network Connections

- You will need to supply an IP address, subnet mask, and gateway IP address.
- The frame rate may drop if multiple streams are transmitted via unicast.
- When connected to multiple devices, the product will transmit data to all devices at the rate supported by the device with the slowest receiving rate.
- Use the product on a secure network (for example, an in-house LAN).

Introduction

Parts of the Camera

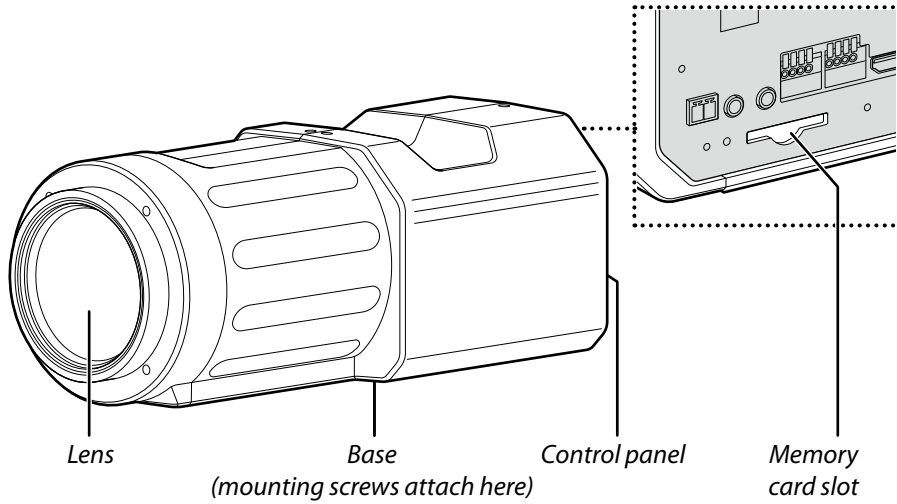

The Control Panel

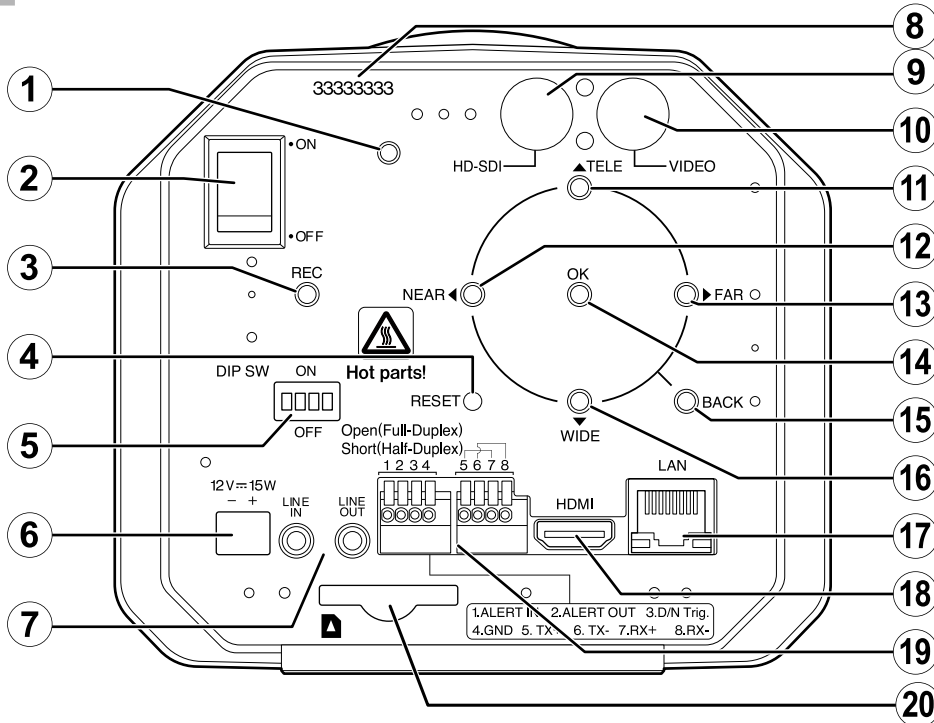

Item	Name
①	Power lamp
②	Power switch
③	REC (record) button
④	RESET button
⑤	DIP switches (4 bits)
⑥	Power connector
⑦	Audio input/output connectors
⑧	Serial number
⑨	HD-SDI output connector
⑩	VIDEO output connector

Item	Name
⑪	TELE button
⑫	NEAR button
⑬	FAR button
⑭	OK/MENU button
⑮	BACK button
⑯	WIDE button
⑰	LAN connector
⑱	HDMI connector
⑲	Eight-pin connector
⑳	Memory card slot

Operating Mode Selection: DIP Switches

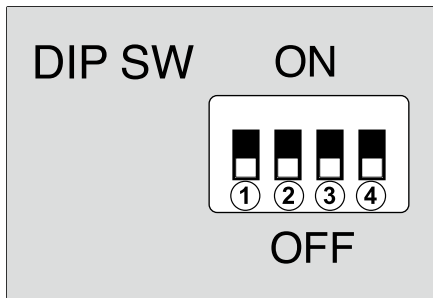

Operating mode	DIP switch			
	①	②	③	④
IP	OFF	ON	—	—
RS485	ON	OFF	—	—
Stand-alone	ON	ON	—	—

RS485 communication	DIP switch			
	①	②	③	④
Full-duplex	—	—	—	ON
Half-duplex	—	—	—	OFF

Eight-Pin Connector Pinout

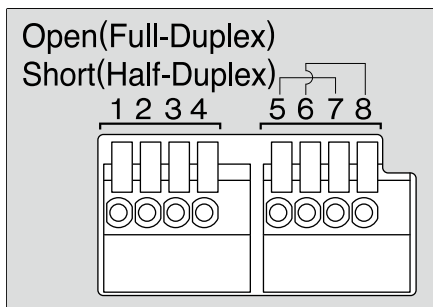

Pin number	Function
①	ALERT IN
②	ALERT OUT
③	Day/night trigger (Open: Day, GND: Night)
④	GND
⑤	RS485 TX+
⑥	RS485 TX-
⑦	RS485 RX+
⑧	RS485 RX-

Installation and Connection

Installation

Use the screw holes on the base to secure the camera to a mount or other surface.

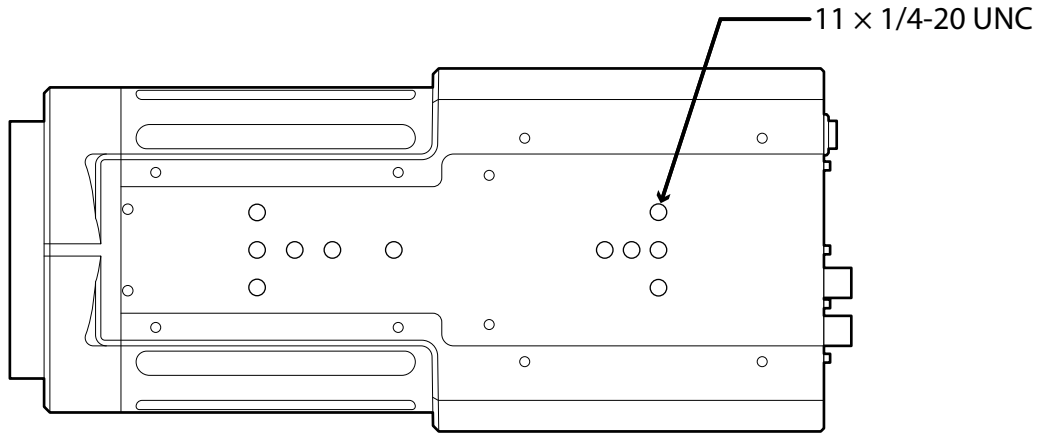

WARNING

Attach the product securely to a surface that can safely bear the combined weight of the camera and associated hardware. Do not mount the camera in unstable locations or locations subject to frequent vibration or attach it to weak materials such as drywall, ALC (autoclaved lightweight concrete), concrete blocks, or plywood. Injury could result should the product fall from its mounting.

CAUTIONS

- Use 1/4", UNC 20 thread screws with a thread engagement length no more than 5.5 mm.
- Install the camera base down.

Screw Hole Specifications

The specifications for the screw holes on the base of the camera are as follows:

	Type	Quantity	Depth	Tightening torque
Base	1/4", UNC 20 thread	11	5.5 mm	240–300 N•cm

- 3 Select IP mode by setting DIP switch ② to "ON" and DIP switches ①, ③ and ④ to "OFF".

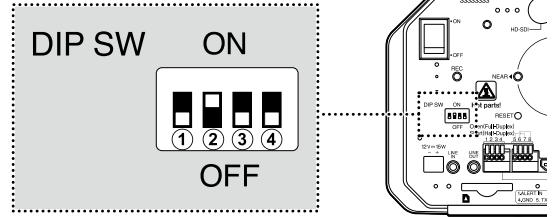

CAUTIONS

- The product cannot be connected directly to telecommunication circuits operated by telecommunications providers (such as mobile or landline telecommunications services or Internet service providers). Connections to the Internet must be made via a router or similar device.
- Use the product on a secure network (for example, an in-house LAN).



TIP For information on using remote-control mounts or ONVIF-compatible control units, see the documentation provided with the device.

Camera Controls

When IP mode is set, operation from the back panel is not possible. However, if the **OK/MENU** button is pressed and held for 3 seconds, the power lamp starts flashing, and operation is possible temporarily. While the power lamp is flashing, zoom, focus, and PTZ control related commands from IP mode are not available. To exit this temporary operation mode, press and hold the **OK/MENU** button for 3 seconds or do not perform any operations for 3 minutes.

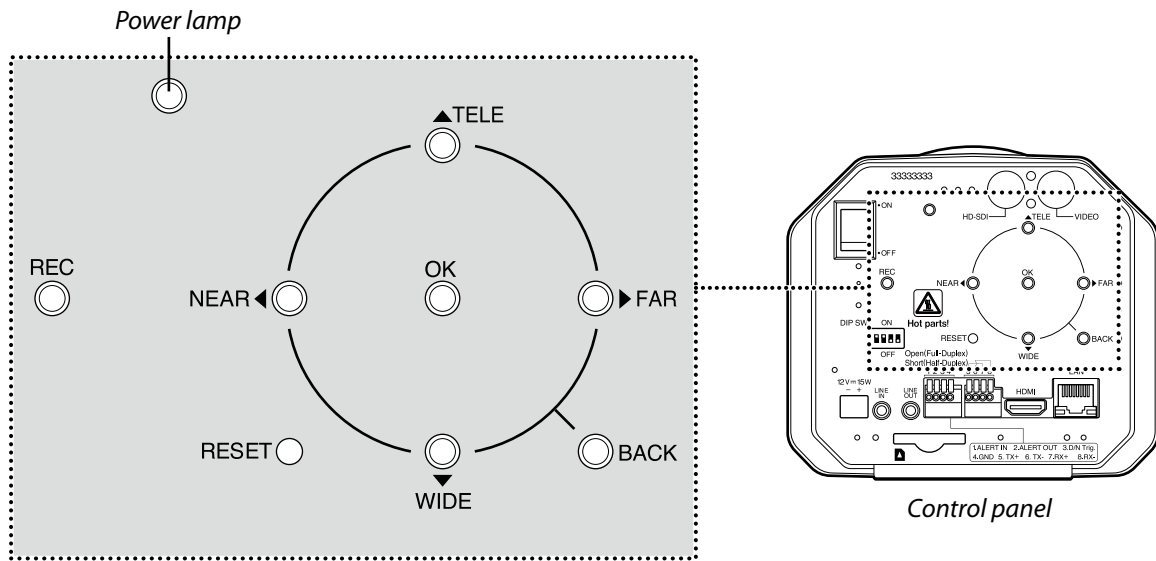

The following buttons are used to navigate the menus and control the camera:

Button	Function (Camera control)
NEAR button	Focus closer to the camera
FAR button	Focus further away from the camera
WIDE button	Zoom out
TELE button	Zoom in
OK/MENU button	Press and hold for 3 seconds to enter or exit temporary back panel operation mode
FAR + NEAR buttons	Press the two buttons at the same time to focus using one-push AF To interrupt AF operation and enable manual focus, press the FAR or NEAR button during AF operation.

Stand-Alone Connections

When the camera is connected to a monitor via an HD-SDI, VIDEO, or HDMI cable, you can view the live feed, control the camera (page 28), and adjust camera settings via the control panel on the back of the camera (page 29).

Connection Schematic

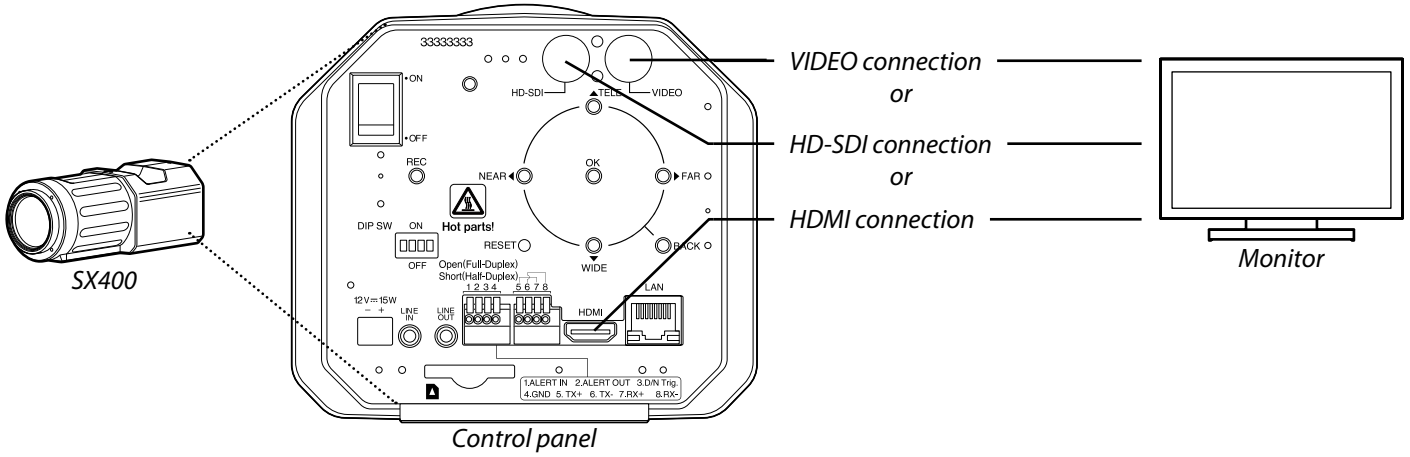

Connecting to a Monitor

- 1 Connect the supplied plug to the power cable and plug the cable into the camera power connector.

CAUTION Use only DC 12 V power.

TIP Customers must supply their own power cable.

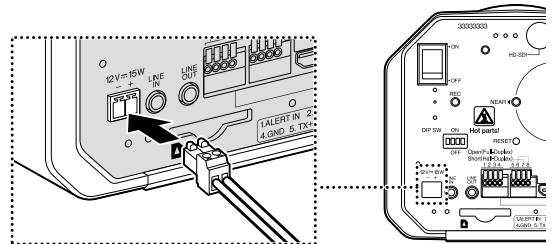

- 2 Connect the camera to the monitor using the appropriate cable.

CAUTION The camera cannot output via HD-SDI while connected via HDMI.

TIP Use an HDMI cable no more than 1.5 m (4.9 ft.) long.

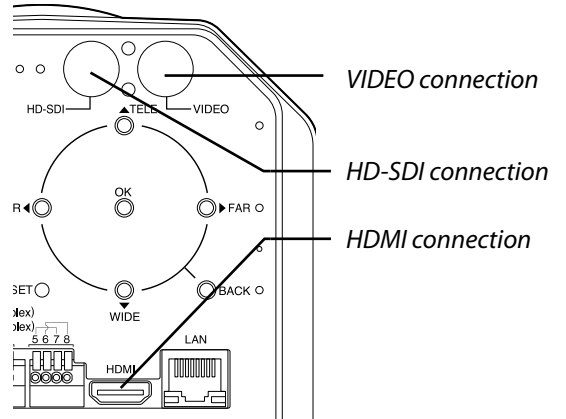

IP Connections—Viewing and Recording the Live Feed

The camera's live feed can be viewed and recorded using a web browser.

Launching a Web Browser

Supported operating systems	Windows 11
Supported web browsers	Google Chrome 142 or later/Microsoft Edge 142 or later

For information on using the web browser, see the browser's online help. To connect to the SX400, you will need to assign it an appropriate IP address. The default IP address and subnet mask assigned to the camera at shipment are as follows:

IP address	192.168.1.10
Subnet mask	255.255.255.0

- 1 Turn on the camera and computer.
- 2 Launch a web browser.
- 3 Enter the product IP address in the address bar ("http://[IP address]").
An administrator account creation dialog will be displayed.
- 4 Enter a user name and password.
At shipment, the user name and password fields are blank.

- Enter a user name and password, both of which can be from 8 to 15 characters long. Take all steps necessary to protect the password.
- The camera must then be re-initialized in stand-alone mode as described below.

Note that this deletes all existing accounts.

- ① Turn the camera off.
- ② Select stand-alone mode using the DIP switches on the rear control panel (page 2).
- ③ Turn the camera on.
- ④ Press and hold the **OK/MENU** button on the rear control panel for 3 seconds to display the menus.
- ⑤ Select **RESET > IP ADDRESS SETTINGS RESET** in the setup menu (page 41).
- ⑥ Turn the camera off and return to Step 3 of "Internet Protocol (IP) Connections" (page 4).

TIPS

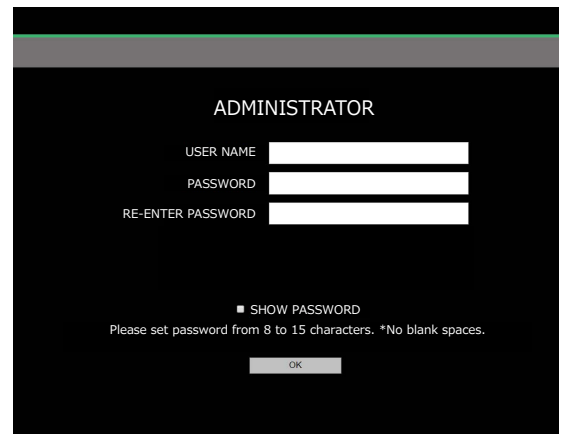

- 5 Click **OK**.
Camera settings will be displayed.

IP Connections—Preferences

Adjust camera settings.

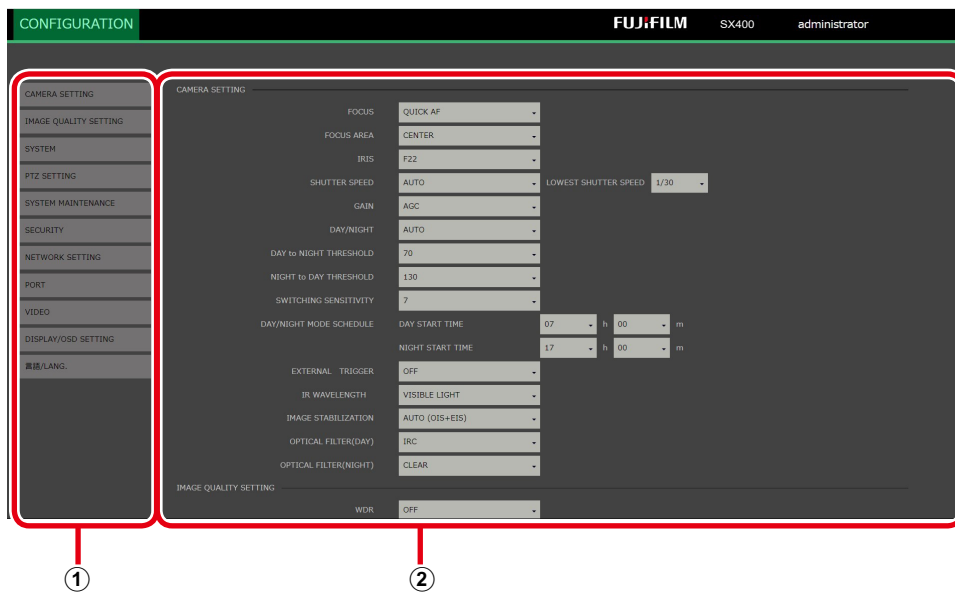

Choosing a category (1) displays the associated settings (2).

Category	Description
CAMERA SETTING	Adjust basic camera settings.
IMAGE QUALITY SETTING	Adjust image quality settings.
SYSTEM	View the firmware version and other information. You can also set the camera clock and adjust other system-related settings.
PTZ SETTING	Adjust settings for remote-control mounts.
SYSTEM MAINTENANCE	Restart the camera, update camera firmware, and perform other forms of system maintenance.
SECURITY	Adjust network security settings.
NETWORK SETTING	Adjust basic network settings.
PORT	Choose ports for HTTP or RTSP.
VIDEO	Adjust video system and streaming settings.
DISPLAY/OSD SETTING	Adjust display settings.
言語/LANG.	Choose a language for camera menus and displays.

CAUTION Do not insert or remove memory cards while the camera is on. Failure to observe this precaution could corrupt image files or damage the memory card.

CAMERA SETTING

Adjust basic camera settings.

FOCUS

Choose how the camera focuses.

Option	Description
CONTINUOUS AF	The camera adjusts focus continuously in response to changes in the distance to the subject. AF SENSITIVITY: This property determines whether the focus system will continue to track the current subject after a new subject enters the focus area at a different distance from the camera. The higher the value, the longer the camera will wait before switching subjects.
QUICK AF	The camera focuses on the subject at the center of the frame for one shot only after zoom is adjusted. Focus can be adjusted manually when zoom is not in use.
MF	Auto focus is OFF. Focus manually on the intended location.

FOCUS AREA

Choose how the camera selects the focus area.

Option	Description
CENTER	The camera focuses on the subject at the center of the frame.
AREA	The position and size of the focus area for autofocus can be chosen by selecting a contiguous range of cells in a 9×5 grid.

IRIS

Choose the aperture value (iris). See “Specifications” (page 44) for supported values.

SHUTTER SPEED

Choose the shutter speed.

Option	Description
AUTO	The camera adjusts shutter speed automatically. You can choose the minimum shutter speed.
MANUAL	Choose the shutter speed manually.

GAIN

Adjust image brightness.

Option	Description
MANUAL	Choose a value for gain.
AGC	The camera adjusts gain automatically to brighten the image when lighting is poor.
HYPHER-AGC	The maximum sensitivity is increased over automatic gain control. Noise increases, but it is suitable for shooting in darker locations.

DAY/NIGHT

In day/night mode, the camera records in color when the subject is brightly lit and in black-and-white when the subject is poorly lit. This option is available when **OFF** is selected for **EXTERNAL TRIGGER**.

Option	Description
AUTO	The camera selects day or night mode automatically according to lighting conditions. You can choose the lighting conditions that trigger the switch when AUTO is selected: <ul style="list-style-type: none"> • DAY to NIGHT THRESHOLD: Choose the brightness threshold that triggers the switch from day to night (0–255). • NIGHT to DAY THRESHOLD: Choose the brightness threshold that triggers the switch from night to day (0–255). • SWITCHING SENSITIVITY: Choose how long (0–60 S) the camera waits to switch modes once the brightness threshold is crossed.
SCHEDULED	The camera switches to day or night mode at a selected time. <ul style="list-style-type: none"> • DAY START TIME: Choose a time from 00:00 to 23:59. • NIGHT START TIME: Choose a time from 00:00 to 23:59.
AUTO & SCHEDULED	Choose a light trigger and time for switching between day and night modes. <ul style="list-style-type: none"> • DAY to NIGHT THRESHOLD: Choose the brightness threshold that triggers the switch from day to night (0–255). • NIGHT to DAY THRESHOLD: Choose the brightness threshold that triggers the switch from night to day (0–255). • SWITCHING SENSITIVITY: Choose how long (0–60 S) the camera waits to switch modes once the brightness threshold is crossed. • DAY START TIME: Choose a time from 00:00 to 23:59. • NIGHT START TIME: Choose a time from 00:00 to 23:59.
DAY	The camera operates in day mode at all times.
NIGHT	The camera operates in night mode at all times.

 **TIP** The **CAMERA SETTING > DAY/NIGHT, EXTERNAL TRIGGER, IR WAVELENGTH, OPTICAL FILTER(DAY), and OPTICAL FILTER(NIGHT)** and **OPTICAL FILTER(NIGHT)** preferences are linked. For more information, see “Lighting Triggers” (page 13).

EXTERNAL TRIGGER

Choose whether day/night selection is performed in response to an external trigger.

Option	Description
ON(VLC)	Applies a VLC (Visible Light Cut) filter to the external trigger. The optical filters selected for day/night are disabled.
ON(CLEAR)	Replaces the filter with clear glass. The optical filters selected for day/night are disabled.
OFF	The camera does not respond to the external trigger.

 **TIP** The **CAMERA SETTING > DAY/NIGHT, EXTERNAL TRIGGER, IR WAVELENGTH, OPTICAL FILTER(DAY), and OPTICAL FILTER(NIGHT)** preferences are linked. For more information, see “Lighting Triggers” (page 13).

IR WAVELENGTH

Match the IR wavelength to the infrared light source used. See “Specifications” (page 44) for supported values.

 **TIP** The **CAMERA SETTING > DAY/NIGHT, EXTERNAL TRIGGER, IR WAVELENGTH, OPTICAL FILTER(DAY), and OPTICAL FILTER(NIGHT)** preferences are linked. For more information, see “Lighting Triggers” (page 13).

IMAGE STABILIZATION

Choose an image stabilization option adapted to the scene.

Option	Description
AUTO (OIS+EIS)	The camera combines optical and electronic image stabilization for results best suited to the scene.
OIS	Reduce the effects of camera shake using optical image stabilization.
EIS	Reduce the effects of camera shake using electronic image stabilization.
OFF	Image stabilization disabled.

OPTICAL FILTER(DAY)

Choose an optical filter for day mode.

Option	Description
IRC	Enable the IRC filter, blocking infrared light and recording only visible-light footage.
VLC	Enable the VLC filter, blocking visible light and recording only infrared footage.

 **TIP** The **CAMERA SETTING > DAY/NIGHT, EXTERNAL TRIGGER, IR WAVELENGTH, OPTICAL FILTER(DAY), and OPTICAL FILTER(NIGHT)** preferences are linked. For more information, see “Lighting Triggers” (page 13).

OPTICAL FILTER(NIGHT)

Choose an optical filter for night mode.

Option	Description
CLEAR	Record footage in both infrared and visible light.
VLC	Enable the VLC filter, blocking visible light and recording only infrared footage.

 **TIP** The **CAMERA SETTING > DAY/NIGHT, EXTERNAL TRIGGER, IR WAVELENGTH, OPTICAL FILTER(DAY), and OPTICAL FILTER(NIGHT)** preferences are linked. For more information, see “Lighting Triggers” (page 13).

Lighting Triggers

Day/night selection can be configured in any of the following three ways:

Configuration	Description	Configured using	
		Menu item	Option
① Auto	Day/night selection is performed automatically according to a schedule and/or lighting conditions.	CAMERA SETTING > DAY/NIGHT	AUTO, SCHEDULED, or AUTO & SCHEDULED
② Manual	Day/night selection is performed manually.		DAY or NIGHT
③ External trigger	Day/night selection is performed in response to input from an external trigger.	CAMERA SETTING > EXTERNAL TRIGGER	ON(VLC)*, ON(CLEAR)*, or OFF

* The optical filters chosen for day/night do not apply if a signal is received from the external trigger when ON(VLC) or ON(CLEAR) is selected for EXTERNAL TRIGGER. If no signal is received or if OFF is selected, the optical filter will function as shown in the following table.

The following table shows relation between the filter selected for day/night, image color, and wavelength:

Option	Filter	Image color	CONFIGURATION > CAMERA SETTING > IR WAVELENGTH	
			Status	Supported wavelengths
DAY	IRC	Color	Disabled	Visible light only
	VLC	Black and white		808 nm only
NIGHT	CLEAR		Black and white	Enabled
	VLC			

IMAGE QUALITY SETTING

Adjust image quality settings.

WDR

Use with high-contrast subjects to reveal details “washed out” in the highlights and lost in the shadows. Choose higher values for high-contrast subjects.

BACKLIGHT CORRECTION

Reduce loss of detail in the shadowed areas of backlit subjects. The higher the value, the greater the effect.

HEAT HAZE REDUCTION

Reduce the wavering effect of heat haze, making the image clearer overall. The higher the value, the greater the effect.

FOG REDUCTION

Make images where the subject is obscured by fog more vivid and easier to see. The higher the value, the greater the effect.

NOISE REDUCTION

Reduce the effects of noise for a smoother picture. The higher the value, the greater the effect.

DIGITAL ZOOM

Choose the digital zoom type.

Option	Description
CONTINUOUS	The camera zooms smoothly from maximum optical zoom to the zoom ratio selected for DIGITAL ZOOM RATIO .
EXTENDED	The camera zooms instantaneously from the current zoom position (whatever it may be) to the zoom ratio selected for DIGITAL ZOOM RATIO .
OFF	Digital zoom disabled.

DIGITAL ZOOM RATIO

Choose the zoom factor for digital zoom.

Options			
2.00	1.75	1.50	1.25

USE SETTING

Choose a shooting preset.

Option	Description
SURVEILLANCE	Emphasize outlines.
MOVIE PRODUCTION	Choose for accurate color reproduction when shooting non-surveillance footage at social gatherings or other events.

BRIGHTNESS

Adjust brightness. The further the slider is to the right, the greater the effect.

CONTRAST

Adjust contrast. The further the slider is to the right, the greater the effect.

SATURATION

Adjust color saturation. The further the slider is to the right, the greater the effect.

SHARPNESS

Make outlines more or less sharply defined. The further the slider is to the right, the greater the effect.

WHITE BALANCE

Match white balance to the light source (for example, sunlight or artificial lighting).

Option	Description
AUTO	The camera adjusts white balance automatically.
AUTO WHITE PRIORITY	The camera sets white balance to a high level.
CUSTOM 1/CUSTOM 2	Measure a value for white balance using a piece of paper or other white reference object.
FINE	For subjects lit by direct sunlight.
SHADE	For subjects in the shade or under overcast skies.
COLOR TEMPERATURE	Choose a color temperature (3000K, 5000K, or 9000K).



TIP After choosing an option for white balance, you can adjust white balance shift.

SYSTEM

View the firmware version and other information. You can also set the camera clock and adjust other system-related settings.

MODEL NAME

View the camera model name.

SERIAL NO.

View the product serial number.

FW VER. (CAMERA)

View the camera firmware version.

FW VER. (SYSTEM)

View the system firmware version.

FW VER. (LENS)

View the lens firmware version.

APPLICATION VER.

View the application version.

TIME ZONE

Choose a time zone.

NTP SERVER ADDRESS

Enter the IP address for the NTP (Network Time Protocol) server.

PORT NUMBER

Choose the NTP server port.

CHECKING INTERVAL

Choose how often the camera checks the NTP server port.

PRIORITY OF TIME SETTING

Choose whether the time display matches the camera's internal clock (**DEVICE**) or the time reported by the NTP server (**NTP**).

Option	Description
DEVICE	The display shows the time reported by the camera's internal clock.
NTP	The display shows the time reported by the NTP server.

IN-CAMERA TIME SETTING

Set the camera clock.

ABOUT DEVICE

View OSS information.

PTZ SETTING

Adjust settings for remote-control mounts.

 **TIP** You will need to turn the camera off and then on again after adjusting settings in this menu.

RS485 BAUD RATE

Choose the baud rate for data transmitted via RS485.

Options					
115200bps	38400bps	19200bps	9600bps	4800bps	2400bps

RS485 ID

Choose the RS485 ID (1–31).

RS485 TERMINATION

Select **ON** to enable the RS485 termination resistor.

PTZ POSITION INQUIRY

Choose whether the camera queries remote-control mounts for pan and tilt positions.

 **CAUTION** Select **ON** when using the camera with remote-control mounts that support position queries.

Pelco-P/Pelco-D

Choose a communications protocol.

PELCO CMD INTERVAL

Choose the interval at which the camera sends Pelco commands to remote-control mounts (10–300 msec).

PAN TILT SPEED CONTROL

Choose whether to control the pan tilt speed according to the zoom magnification.

PAN/TILT WITH OIS & EIS

Choose whether to enable **PAN/TILT WITH OIS & EIS**.

* Note that this option is available only when the camera is connected to a computer in IP mode and is also connected to a remote-control mount via the RS485 connection.

SYSTEM MAINTENANCE

Restart the camera, update camera firmware, and perform other forms of system maintenance.

REBOOT

Select **OK** to restart the camera.

RESET SETTINGS

Select **OK** to restore camera settings to their default values. Items in the following menus are not affected:

- NETWORK SETTING

IMPORT CONFIGURATION FILE

Import settings from a camera settings file. Click **BROWSE** and choose a settings file created using **EXPORT TO CONFIGURATION FILE**.

EXPORT TO CONFIGURATION FILE

Export camera settings. Click **OK** to download the settings folder.

FIRMWARE UPDATE

Update camera, system, or lens firmware. Click **BROWSE** and select the file containing the new firmware version to begin the update. Be sure to keep all firmware up-to-date.

The latest firmware is available at the following website.

<https://global.fujifilm.com/en/business-optical-devices/cctv/sx>



COPY LOG DATA

Save a copy of camera logs. Click **BROWSE**, choose a destination, and click **OK** to save the logs.

CHANGE PASSWORD

Change the camera login password.

SECURITY

Adjust network security settings.

RTSP AUTHENTICATION

Choose an RTSP authentication method (**DISABLE**, **BASIC**, or **DIGEST**).

RTSP AUTHENTICATION ALGORITHM

Choose an algorithm for **DIGEST** authentication (**MD5** or **SHA256**).

HTTP AUTHENTICATION

Choose an HTTP authentication method (**BASIC** or **DIGEST**).

 **TIP** The MD5 authentication algorithm is used for HTTP. Users wishing to switch to SHA256 can do so via CGI commands. This service can be requested from your retailer.

NETWORK SETTING

Adjust basic network settings.

IPv4 ADDRESS

Enter the camera's IPv4 address.

IPv4 SUBNET MASK

Enter the camera's IPv4 subnet mask.

IPv4 DEFAULT GATEWAY

Enter the camera's default IPv4 gateway.

MAC ADDRESS

View the camera's MAC address.

IPv4 MTU

Choose the maximum volume of data that can be transmitted per packet (frame).

PREFERRED DNS SERVER

Enter the IP address of the primary DNS server.

ALTERNATE DNS SERVER

Enter the IP address of the secondary DNS server.

IPv4 ADDRESS

Choose how the camera's IPv4 address is assigned.

Option	Description
MANUAL	Enter the camera's IPv4 address manually.
AUTO (DHCP)	Enable automatic IPv4 address allocation via the Dynamic Host Configuration Protocol (DHCP).

PORT

Adjust port settings.

HTTP PORT

Choose the HTTP port.

RTSP PORT

Choose the RTSP port.

VIDEO

Adjust video settings.

VIDEO FORMAT

Choose the frame size for video shot using the camera.

ENCODING TYPE

Choose the encoding method.

BIT RATE TYPE

Choose a variable or fixed bit rate for video encoding.

Option	Description
CBR	Fixed
VBR	Variable

* Note that this option is available only when H.264 encoding is selected.

FRAME RATE

Choose the frame rate.

* When **1fps** is selected, **I FRAME INTERVAL 0.5s** cannot be set.

* After changing the frame rate, connect to the streaming playback application again.

BIT RATE

Choose the bit rate.

* Note that this option is available only when H.264 encoding is selected.

* It may not be possible to achieve the specified bit rate depending on the subject or the frame rate/video format settings.

I FRAME INTERVAL

Choose the I-Frame interval.

* Note that this option is available only when H.264 encoding is selected.

* When **0.5s** is selected, **FRAME RATE 1fps** cannot be set.

DISPLAY/OSD SETTING

Adjust the display/OSD settings.

DAY & TIME DISPLAY

Choose the date and time display position. Date and time are not displayed if **OFF** is selected.

ID DISPLAY

Choose the ID display position. The ID is not displayed if **OFF** is selected.

ID (CAMERA NAME)

Set the ID (camera name).

* Uppercase characters and numbers can be entered (Lowercase characters cannot be entered).

TITLE DISPLAY

Choose the title display position. The title is not displayed if **OFF** is selected.

EDIT TITLE

Set the title.

* Uppercase characters and numbers can be entered (Lowercase characters cannot be entered).

TIME DISPLAY

Choose the time display format.

DATE DISPLAY FORMAT

Choose the date display format.

言語/LANG.

Choose a language for camera menus and displays.

言語/LANG.

Choose a language.

Defaults

Selecting **OK** for **SYSTEM MAINTENANCE > RESET SETTINGS** restores settings to the following default values:

CAMERA SETTING

Option	Default
FOCUS	QUICK AF
FOCUS AREA	CENTER
IRIS	AUTO
SHUTTER SPEED	AUTO (1/30)
GAIN	AGC
DAY/NIGHT	AUTO <ul style="list-style-type: none"> • DAY to NIGHT THRESHOLD: 70 • NIGHT to DAY THRESHOLD: 130 • SWITCHING SENSITIVITY: 7 S SCHEDULED <ul style="list-style-type: none"> • DAY START TIME: 7:00 • NIGHT START TIME: 17:00
EXTERNAL TRIGGER	OFF
IR WAVELENGTH	VISIBLE LIGHT
IMAGE STABILIZATION	AUTO (OIS+EIS)
OPTICAL FILTER(DAY)	IRC
OPTICAL FILTER(NIGHT)	CLEAR

IMAGE QUALITY SETTING

Option	Default
WDR	OFF
BACKLIGHT CORRECTION	OFF
HEAT HAZE REDUCTION	OFF
FOG REDUCTION	OFF
NOISE REDUCTION	2
DIGITAL ZOOM	OFF
DIGITAL ZOOM RATIO	1.25
USE SETTING	SURVEILLANCE
BRIGHTNESS	50
CONTRAST	50
SATURATION	50
SHARPNESS	80
WHITE BALANCE	AUTO <ul style="list-style-type: none"> • WB SHIFT: R-0, B-0

SYSTEM

Option	Default
MODEL NAME	—
SERIAL NO.	—
FW VER. (CAMERA)	—
FW VER. (SYSTEM)	—
FW VER. (LENS)	—
APPLICATION VER.	—
TIME ZONE	GMT+09:00 OSAKA, SAPPORO, TOKYO
NTP SERVER ADDRESS	—
PORT NUMBER	123
CHECKING INTERVAL	1h
PRIORITY OF TIME SETTING	DEVICE
IN-CAMERA TIME SETTING	—
ABOUT DEVICE	—

PTZ SETTING

Option	Default
RS485 BAUD RATE	9600bps
RS485 ID	7
RS485 TERMINATION	ON
PTZ POSITION INQUIRY	ON
Pelco-P/Pelco-D	Pelco-D
PELCO CMD INTERVAL	300
PAN TILT SPEED CONTROL	OFF
PAN/TILT WITH OIS & EIS	ON

SYSTEM MAINTENANCE

Option	Default
REBOOT	—
RESET SETTINGS	—
IMPORT CONFIGURATION FILE	—
EXPORT TO CONFIGURATION FILE	—
FIRMWARE UPDATE	—
COPY LOG DATA	—
CHANGE PASSWORD	—

SECURITY

Option	Default
RTSP AUTHENTICATION	BASIC
RTSP AUTHENTICATION ALGORITHM	MD5
HTTP AUTHENTICATION	BASIC

NETWORK SETTING

Option	Default
IPv4 ADDRESS	192.168.1.10
IPv4 SUBNET MASK	255.255.255.0
IPv4 DEFAULT GATEWAY	192.168.1.254
MAC ADDRESS	—
IPv4 MTU	1500
PREFERRED DNS SERVER	192.168.1.254
ALTERNATE DNS SERVER	—
IPv4 ADDRESS	MANUAL

PORT

Option	Default
HTTP PORT	80
RTSP PORT	554

VIDEO

Option	Default
VIDEO FORMAT	1080P
ENCODING	H.264
BIT RATE TYPE	CBR
FRAME RATE	30 fps (NTSC), 25 fps (PAL)
BIT RATE	15 Mbps
I FRAME INTERVAL	1 s

DISPLAY/OSD SETTING

Option	Default
DAY & TIME DISPLAY	OFF
ID DISPLAY	OFF
ID (CAMERA NAME)	—
TITLE DISPLAY	OFF
EDIT TITLE	—
TIME DISPLAY	24h
DATE DISPLAY FORMAT	MM-DD-YYYY

言語/LANG.

Option	Default
言語/LANG.	ENGLISH

Stand-Alone Connections—Camera Controls

Use the control panel on the back of the camera for live feed or camera control or adjusting camera settings. To display the menus, press and hold the **OK/MENU** button for 3 seconds.

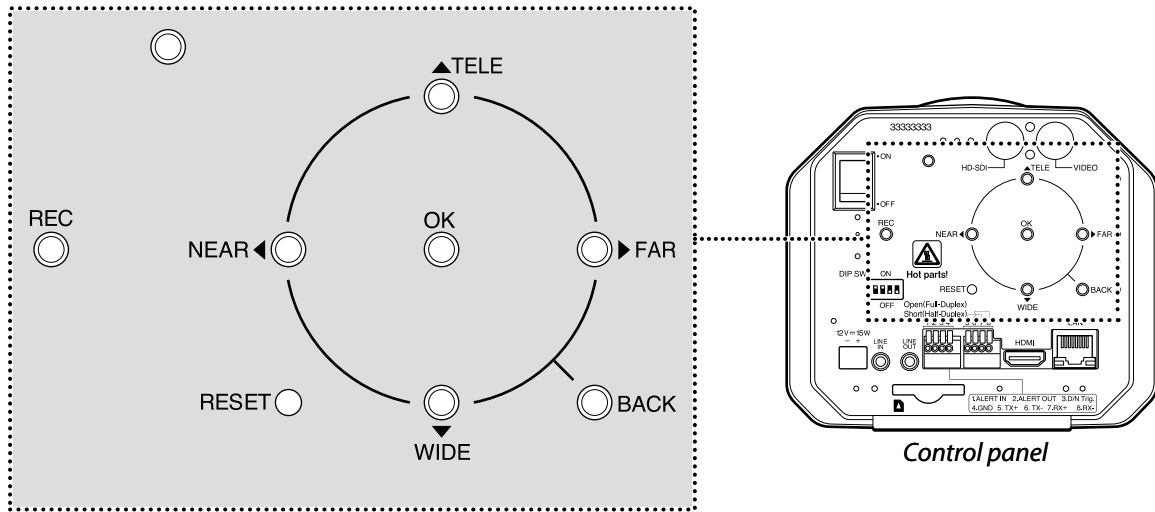

The following buttons are used to navigate the menus and control the camera:

Button	Function	
	Menu navigation	Camera control
NEAR button	Move the cursor left	Focus closer to the camera
FAR button	Move the cursor right	Focus further away from the camera
WIDE button	Move the cursor down	Zoom out
TELE button	Move the cursor up	Zoom in
OK/MENU button	Select the highlighted item	Press and hold for 3 seconds to display the menus
BACK button	Return to the previous display	View or hide the focus area and zoom frames
REC button	Record footage to the SD memory card	
RESET button	Restore factory default settings Note: Pressing and holding the button for 3 seconds displays a confirmation dialog. Follow the on-screen instructions to restore factory default settings.	
FAR + NEAR buttons	—	Press the two buttons at the same time to focus using one-push AF To interrupt AF operation and enable manual focus, press the FAR or NEAR button during AF operation.

TIP Press and hold the **RESET** button for 3 seconds and then select **OK** to restore default settings when prompted. This restores all settings except the IP address to their default values.

Stand-Alone Connections—Camera Menus

Using the Menus

Use the menus to adjust camera settings. Press and hold the control panel **OK** button to display the menus and use the **TELE** (▲), **WIDE** (▼), **NEAR** (◀), and **FAR** (▶) buttons to move the cursor up, down, left, and right, the **OK** button to select highlighted items, and the **BACK** button to exit to the previous menu.

1 Hold the **OK** button for 3 seconds to display the menus.

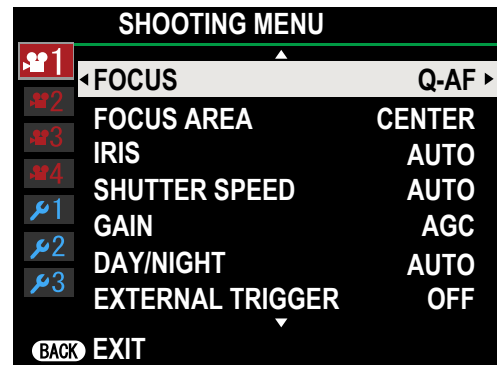

2 Press **NEAR** (◀) to highlight the tab for the current menu.

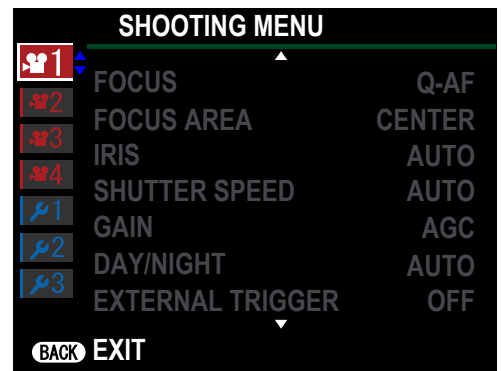

3 Press **TELE** (▲) and **WIDE** (▲) to highlight the tab for the desired menu.

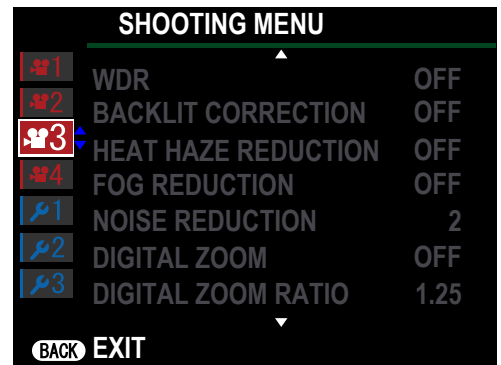

4 Press **FAR** (▶) to place the cursor in the selected menu.

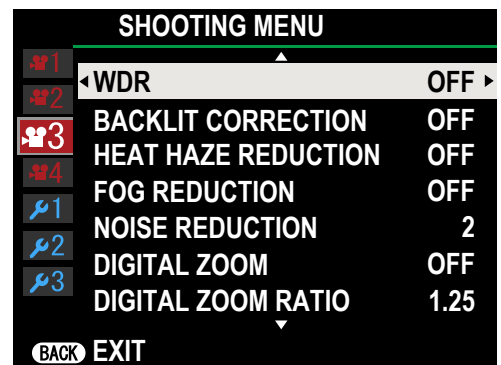

5 Press **TELE** (▲) and **WIDE** (▼) to highlight the desired item.

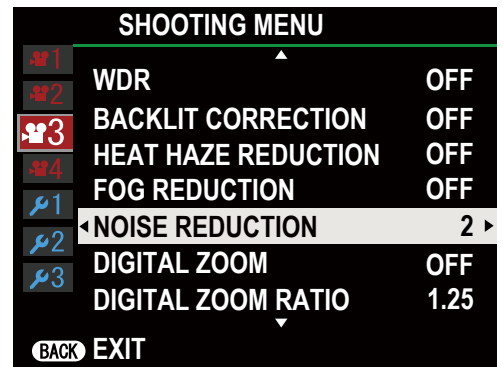

6 Press **FAR** (▶) to view options for the highlighted item.

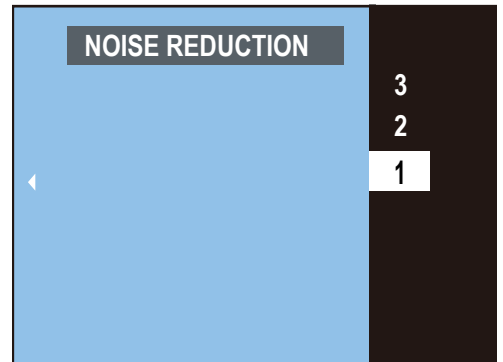

7 Choose the desired option and press **OK**.

SHOOTING MENU 1

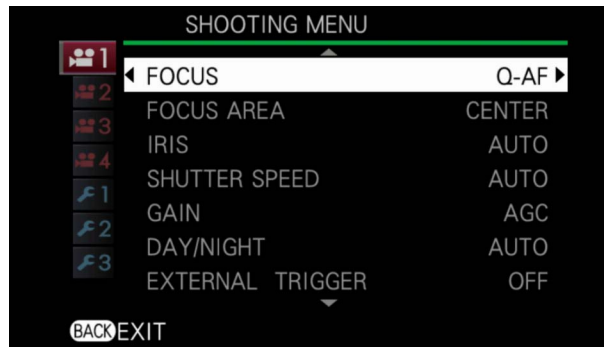

FOCUS

Choose how the camera focuses.

Option	Description
CONTINUOUS AF	The camera adjusts focus continuously in response to changes in the distance to the subject. AF SENSITIVITY: This property determines whether the focus system will continue to track the current subject after a new subject enters the focus area at a different distance from the camera. The higher the value, the longer the camera will wait before switching subjects.
QUICK AF	The camera focuses on the subject at the center of the frame for one shot only after zoom is adjusted. Focus can be adjusted manually when zoom is not in use. To interrupt AF operation and enable manual focus, press the FAR or NEAR button during AF operation.
MF	Auto focus is OFF. Focus manually on the intended location.

FOCUS AREA

Choose how the camera selects the focus area.

Option	Description
CENTER	The camera focuses on the subject at the center of the frame.
AREA	The position and size of the focus area for autofocus can be chosen by selecting a contiguous range of cells in a 9×5 grid.

IRIS

Choose the aperture value (iris). See “Specifications” (page 44) for supported values.

SHUTTER SPEED

Choose the shutter speed.

Option	Description
AUTO	The camera adjusts shutter speed automatically. You can choose the minimum shutter speed.
MANUAL	Choose the shutter speed manually.

GAIN

Adjust image brightness.

Option	Description
MANUAL	Choose a value for gain.
AGC	The camera adjusts gain automatically to brighten the image when lighting is poor.
HYPER-AGC	Sensitivity is increased over automatic gain control. Noise increases, but it is suitable for shooting in darker locations.

DAY/NIGHT

In day/night mode, the camera records in color when the subject is brightly lit and in black-and-white when the subject is poorly lit. This option is available when **OFF** is selected for **EXTERNAL TRIGGER**.

Option	Description
AUTO	The camera selects day or night mode automatically according to lighting conditions. You can choose the lighting conditions that trigger the switch when AUTO is selected: <ul style="list-style-type: none"> • DAY to NIGHT THRESHOLD: Choose the brightness threshold that triggers the switch from day to night (0–255). • NIGHT to DAY THRESHOLD: Choose the brightness threshold that triggers the switch from night to day (0–255). • SWITCHING SENSITIVITY: Choose how long (0–60 S) the camera waits to switch modes once the brightness threshold is crossed.
SCHEDULED	The camera switches to day or night mode at a selected time. <ul style="list-style-type: none"> • DAY START TIME: Choose a time from 00:00 to 23:59. • NIGHT START TIME: Choose a time from 00:00 to 23:59.
AUTO & SCHEDULED	Choose a light trigger and time for switching between day and night modes. <ul style="list-style-type: none"> • DAY to NIGHT THRESHOLD: Choose the brightness threshold that triggers the switch from day to night (0–255). • NIGHT to DAY THRESHOLD: Choose the brightness threshold that triggers the switch from night to day (0–255). • SWITCHING SENSITIVITY: Choose how long (0–60 S) the camera waits to switch modes once the brightness threshold is crossed. • DAY START TIME: Choose a time from 00:00 to 23:59. • NIGHT START TIME: Choose a time from 00:00 to 23:59.
DAY	The camera operates in day mode at all times.
NIGHT	The camera operates in night mode at all times.

 **TIP** The **SHOOTING MENU > DAY/NIGHT, EXTERNAL TRIGGER, IR WAVELENGTH, OPTICAL FILTER(DAY)** and **OPTICAL FILTER(NIGHT)** preferences are linked. For more information, see “Lighting Triggers” (page 33).

EXTERNAL TRIGGER

Choose whether day/night selection is performed in response to an external trigger.

Option	Description
ON(VLC)	Applies a VLC (Visible Light Cut) filter to the external trigger. The optical filters selected for day/night are disabled.
ON(CLEAR)	Replaces the filter with clear glass. The optical filters selected for day/night are disabled.
OFF	The camera does not respond to the external trigger.

 **TIP** The SHOOTING MENU > DAY/NIGHT, EXTERNAL TRIGGER, IR WAVELENGTH, OPTICAL FILTER(DAY) and OPTICAL FILTER(NIGHT) preferences are linked. For more information, see “Lighting Triggers” (page 33).

Lighting Triggers

Day/night selection can be configured in any of the following three ways:

Configuration	Description	Configured using	
		Menu item	Option
① Auto	Day/night selection is performed automatically according to a schedule and/or lighting conditions.	SHOOTING MENU > DAY/NIGHT	AUTO, SCHEDULED, or AUTO & SCHEDULED
② Manual	Day/night selection is performed manually.		DAY or NIGHT
③ External trigger	Day/night selection is performed in response to input from an external trigger.	SHOOTING MENU > EXTERNAL TRIGGER	ON(VLC)*, ON(CLEAR)*, or OFF

* The optical filters chosen for day/night do not apply if a signal is received from the external trigger when ON(VLC) or ON(CLEAR) is selected for EXTERNAL TRIGGER. If no signal is received or if OFF is selected, the optical filter will function as shown in the following table.

The following table shows relation between the filter selected for day/night, image color, and wavelength:

Option	Filter	Image color	SHOOTING MENU > IR WAVELENGTH	
			Status	Supported wavelengths
DAY	IRC	Color	Disabled	Visible light only
	VLC			808 nm only
NIGHT	CLEAR	Black and white	Enabled	950 nm, 940 nm, 850 nm, 808 nm, visible light
	VLC			

SHOOTING MENU 2

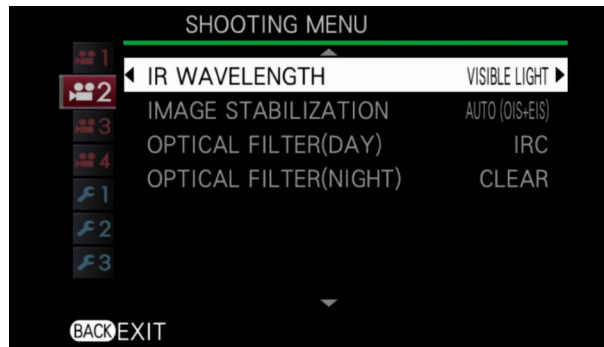

IR WAVELENGTH

Match the IR wavelength to the infrared light source used. See “Specifications” (page 44) for supported values.

TIP The SHOOTING MENU > DAY/NIGHT, EXTERNAL TRIGGER, IR WAVELENGTH, OPTICAL FILTER(DAY) and OPTICAL FILTER(NIGHT) preferences are linked. For more information, see “Lighting Triggers” (page 33).

IMAGE STABILIZATION

Choose an image stabilization option adapted to the scene.

Option	Description
AUTO (OIS+EIS)	The camera combines optical and electronic image stabilization for results best suited to the scene.
OIS	Reduce the effects of camera shake using optical image stabilization.
EIS	Reduce the effects of camera shake using electronic image stabilization.
OFF	Image stabilization disabled.

OPTICAL FILTER(DAY)

Choose an optical filter for day mode.

Option	Description
IRC	Enable the IRC filter, blocking infrared light and recording only visible-light footage.
VLC	Enable the VLC filter, blocking visible light and recording only infrared footage.

 **TIP** The SHOOTING MENU > DAY/NIGHT, EXTERNAL TRIGGER, IR WAVELENGTH, OPTICAL FILTER(DAY) and OPTICAL FILTER(NIGHT) preferences are linked. For more information, see “Lighting Triggers” (page 33).

OPTICAL FILTER(NIGHT)

Choose an optical filter for night mode.

Option	Description
CLEAR	Record footage in both infrared and visible light.
VLC	Enable the VLC filter, blocking visible light and recording only infrared footage.

 **TIP** The SHOOTING MENU > DAY/NIGHT, EXTERNAL TRIGGER, IR WAVELENGTH, OPTICAL FILTER(DAY) and OPTICAL FILTER(NIGHT) preferences are linked. For more information, see “Lighting Triggers” (page 33).

SHOOTING MENU 3



WDR

Use with high-contrast subjects to reveal details “washed out” in the highlights and lost in the shadows. Choose higher values for high-contrast subjects.

BACKLIGHT CORRECTION

Reduce loss of detail in the shadowed areas of backlit subjects. The higher the value, the greater the effect.

HEAT HAZE REDUCTION

Reduce the wavering effect of heat haze, making the image clearer overall. The higher the value, the greater the effect.

FOG REDUCTION

Make images where the subject is obscured by fog more vivid and easier to see. The higher the value, the greater the effect.

NOISE REDUCTION

Reduce the effects of noise for a smoother picture. The higher the value, the greater the effect.

DIGITAL ZOOM

Choose the digital zoom type.

Option	Description
CONTINUOUS	The camera zooms smoothly from maximum optical zoom to the zoom ratio selected for DIGITAL ZOOM RATIO .
EXTENDED	The camera zooms instantaneously from the current zoom position (whatever it may be) to the zoom ratio selected for DIGITAL ZOOM RATIO .
OFF	Digital zoom disabled.

DIGITAL ZOOM RATIO

Choose the zoom factor for digital zoom.

Options			
2.00	1.75	1.50	1.25

SHOOTING MENU 4



USE SETTING

Choose a shooting preset.

Option	Description
SURVEILLANCE	Emphasize outlines.
MOVIE PRODUCTION	Choose for accurate color reproduction when shooting non-surveillance footage at social gatherings or other events.

BRIGHTNESS

Adjust brightness. The higher the value, the greater the effect.

CONTRAST

Adjust contrast. The higher the value, the greater the effect.

SATURATION

Adjust color saturation. The higher the value, the greater the effect.

SHARPNESS

Make outlines more or less sharply defined. The higher the value, the greater the effect.

WHITE BALANCE

Match white balance to the light source (for example, sunlight or artificial lighting).

Option	Description
AUTO	The camera adjusts white balance automatically.
AUTO WHITE PRIORITY	The camera sets white balance to a high level.
CUSTOM 1/CUSTOM 2	Measure a value for white balance using a piece of paper or other white reference object.
FINE	For subjects lit by direct sunlight.
SHADE	For subjects in the shade or under overcast skies.
COLOR TEMPERATURE	Choose a color temperature (3000K, 5000K, or 9000K).

TIP After choosing an option for white balance, you can adjust white balance shift.

SET-UP 1

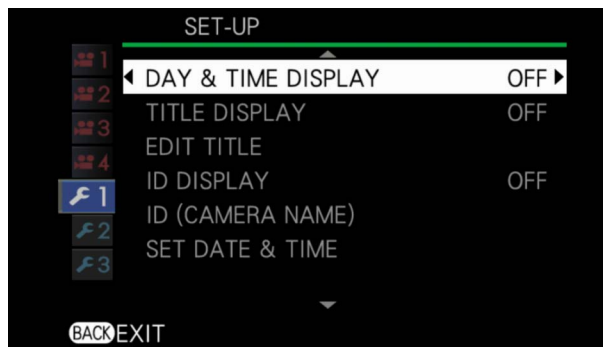

DAY & TIME DISPLAY

Choose the date and time display position. Date and time are not displayed if **OFF** is selected.

TITLE DISPLAY

Choose the title display position. The title is not displayed if **OFF** is selected.

EDIT TITLE

Set the title.

* Uppercase characters and numbers can be entered (Lowercase characters cannot be entered).

ID DISPLAY

Choose the ID display position. The ID is not displayed if **OFF** is selected.

ID (CAMERA NAME)

Set the ID (camera name).

* Uppercase characters and numbers can be entered (Lowercase characters cannot be entered).

SET DATE & TIME

Choose the date and time display format.

SET-UP 2

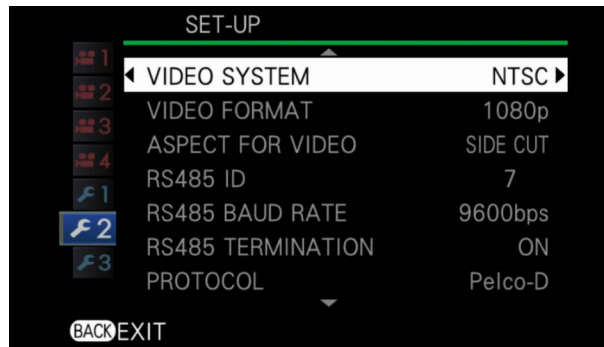

VIDEO SYSTEM

Choose the standard used for video output from the camera.

VIDEO FORMAT

Choose the frame size at which video is output from the camera.

ASPECT FOR VIDEO

Choose how video is displayed on monitors with an aspect ratio that does not match the selected format.

Option	Description
SIDE CUT	The image is cropped to fit the display.
LETTERBOX	The image is displayed at its original aspect ratio with black bars above and below.
SQUEEZE	Video with an aspect ratio of 16:9 is reformatted to fit displays with a 4:3 aspect ratio.

RS485 ID

Set the RS485 ID.

RS485 BAUD RATE

Choose the baud rate for data transmitted via RS485.

RS485 TERMINATION

Select ON to enable the RS485 termination resistor.

PROTOCOL

Choose a communications protocol for RS485 connections.

SET-UP 3

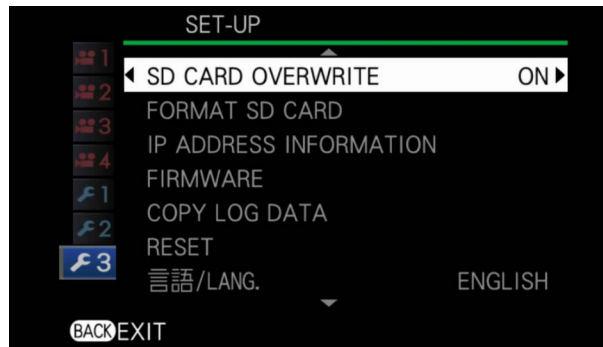

SD CARD OVERWRITE

Choose whether the camera overwrites existing data when the memory card is full.

Option	Description
ON	When the memory card is full, the camera overwrites existing files to make room for new data.
OFF	The camera stops recording data when the memory card is full. You have the option of displaying the amount space available on the card.

FORMAT SD CARD

Select **OK** to format the memory card. Any existing data on the card will be deleted.

IP ADDRESS INFORMATION

View camera IP address settings.

FIRMWARE

Update camera, system, or lens firmware. If the memory card inserted in the camera contains a new version of the camera firmware, selecting this option will display a confirmation dialog. Select **FIRMWARE UPDATE** to perform the update. Be sure to keep all firmware up-to-date.

The latest firmware is available at the following website.
<https://global.fujifilm.com/en/business-optical-devices/cctv/sx>



COPY LOG DATA

Copy log data to the memory card. Selecting this option displays a confirmation dialog. Select **OK** to perform the update.

RESET

Option	Description
RESET SETTINGS	Reset camera settings to their default values. Settings can also be reset by pressing and holding the control panel RESET button for 3 seconds.
IP ADDRESS SETTINGS RESET	Reset camera IP address settings.

言語/LANG.

Choose a language.

Defaults

The **RESET** option in the setup menu restores settings to the following default values:

SHOOTING MENU

Option	Default
FOCUS	QUICK AF
FOCUS AREA	CENTER
IRIS	AUTO
SHUTTER SPEED	AUTO (1/30)
GAIN	AGC
DAY/NIGHT	AUTO <ul style="list-style-type: none"> • DAY to NIGHT THRESHOLD: 70 • NIGHT to DAY THRESHOLD: 130 • SWITCHING SENSITIVITY: 7 S
EXTERNAL TRIGGER	OFF
IR WAVELENGTH	VISIBLE LIGHT
IMAGE STABILIZATION	AUTO (OIS+EIS)
OPTICAL FILTER(DAY)	IRC
OPTICAL FILTER(NIGHT)	CLEAR
WDR	OFF
BACKLIGHT CORRECTION	OFF
HEAT HAZE REDUCTION	OFF
FOG REDUCTION	OFF
NOISE REDUCTION	2
DIGITAL ZOOM	OFF
DIGITAL ZOOM RATIO	1.25
USE SETTING	SURVEILLANCE
BRIGHTNESS	50
CONTRAST	50
SATURATION	50
SHARPNESS	80
WHITE BALANCE	AUTO <ul style="list-style-type: none"> • WB SHIFT: R-0, B-0

SET-UP

Option	Default
DAY & TIME DISPLAY	OFF
TITLE DISPLAY	OFF
EDIT TITLE	—
ID DISPLAY	OFF
ID (CAMERA NAME)	—
SET DATE & TIME	<ul style="list-style-type: none"> • TIME DISPLAY: 24h • DATE DISPLAY FORMAT: MM-DD-YYYY
VIDEO SYSTEM	NTSC
VIDEO FORMAT	1080p
ASPECT FOR VIDEO	SIDE CUT
RS485 ID	7
RS485 BAUD RATE	9600bps
RS485 TERMINATION	ON
PROTOCOL	Pelco-D
SD CARD OVERWRITE	ON
FORMAT SD CARD	—
IP ADDRESS INFORMATION	—
FIRMWARE	—
COPY LOG DATA	—
RESET	—
言語/LANG.	ENGLISH

Troubleshooting

Should the product fail to function as expected, consult the table below. If you are unable to find a solution here, contact your local Fujifilm distributor.

Problem	Solution
No video, or the image in the video is dark.	<ul style="list-style-type: none"> • The camera is off: Check that the cables are correctly connected, the power lamp is lit, and the correct voltage is being supplied to the lens. • The cables are not correctly connected: Check that the cables are correctly connected. • The lens cap is on: Remove the lens cap. • The iris is stopped down to the minimum aperture: Select maximum aperture. • Shutter speed requires adjustment: Select an appropriate value for shutter speed.
The image in the video is “washed out”.	<ul style="list-style-type: none"> • Camera white balance, gain, shutter speed, or other settings require adjustment: Confirm that settings are adjusted appropriately. • Aperture requires adjustment: Adjust aperture appropriately.
The image in the video is out of focus.	The lens is dirty: Clean the lens.
Spots appear in the video.	
Menus are not displayed.*	Press and hold the OK button for 3 seconds to display the menus (page 28).
Camera settings cannot be reset.*	Press and hold the RESET button for 3 seconds to restore default settings (page 28).
The camera does not function as expected.*	The DIP switches are not in the correct positions: Use the DIP switches to select stand-alone mode (page 2).
The monitor is blank.*	The camera is connected to a PAL display: The VIDEO SYSTEM option in the camera setup menu defaults NTSC. No video will be displayed on PAL devices at default settings. Use an NTSC display or adjust output settings for each of the three connection types (HDMI, SD-SDI, or VIDEO).

* Stand-alone connections.

Specifications

Model	FUJIFILM SX400
Focal length	12.5–400 mm
Optical zoom	32×
Digital zoom	1.25×, 1.5×, 1.75×, 2×
Max. aperture	f/2.8 (12.5–200 mm) f/5.2 (400 mm)
Minimum object distance (M.O.D.) ¹	10 m
Image sensor	CMOS sensor
Video	<ul style="list-style-type: none"> • File format: MOV • Video compression: H.264 compliant
Frame size	1920 × 1080, 1280 × 720, 640 × 480 (NTSC), 768 × 576 (PAL)
Metering	Average
Focus modes	Continuous AF, Quick AF, MF
Aperture selection	Auto, Manual (f/2.8–f/16)
Shutter speed	Auto (with minimum speed selection of 1/8 – 1/125 s), manual (1 – 1/32000 s)
Gain adjustment	Manual (ISO 400 – ISO 819200), AGC, HYPER AGC
Day/night selection	AUTO, SCHEDULED, AUTO & SCHEDULED, DAY, NIGHT
Wavelengths	VISIBLE LIGHT, 950 nm, 940 nm, 850 nm, 808 nm
Image stabilization	Available (AUTO (OIS+EIS), OIS, EIS, OFF)
Wide dynamic range	Selectable (2 levels)
Back light compensation	Selectable (2 levels)
Heat haze reduction	Selectable (3 levels)
Fog reduction	Selectable (3 levels)
Noise reduction	Selectable (3 levels)
Shooting Mode Preset	SURVEILLANCE, MOVIE PRODUCTION
Brightness	Selectable (100 levels)
Contrast	Selectable (100 levels)
Saturation	Selectable (100 levels)
Sharpening	Selectable (100 levels)
White balance	AUTO, AUTO WHITE PRIORITY, CUSTOM 1, CUSTOM 2, FINE, SHADE, COLOR TEMPERATURE (choose a color temperature in degrees Kelvin from 3000K, 5000K, and 9000K)
Image output connectors	HDMI, HD-SDI, composite (BNC)
Audio input/output	<ul style="list-style-type: none"> • Input impedance: 40K Ω • Output impedance: 200 Ω
Video output	<ul style="list-style-type: none"> • NTSC: 1080p, 720p, 480p • PAL: 1080p, 720p, 576p
Encoding type	H.264, MJPEG
Bit rate type	CBR, VBR
Frame rate ²	1—30 fps (H.264/NTSC), 1—25 fps (H.264/PAL), 1—15 fps (MJPEG/NTSC), 1—13 fps (MJPEG/PAL)
Bit rate	1—18 Mbps
I frame interval	0.5s, 1s
External interface	100BASE-T, RS485, external trigger (DAY/NIGHT)
Baud rate	152000 bps, 38400 bps, 19200 bps, 9600 bps, 4800 bps, 2400 bps
Internet protocol	ONVIF (port number 8080) HTTP, RTSP
RS485 protocol	Pelco-D, P (includes custom commands)
RS485 communication	Full-duplex, Half-duplex
Power source	DC 12 V
Power consumption	15 W
Dimensions (W × H × D)	121 mm × 134 mm × 302 mm/4.76 in. × 5.28 in. × 11.89 in.
Weight	Approx. 3.9 kg/8.60 lb
Operating environment	<ul style="list-style-type: none"> • Temperature: –10 °C – +50 °C/+14 °F – +122 °F • Humidity: 10% – 80% (no condensation)
Tilt limit	±45° from level (base down)

1 From the foremost part of the forward lens.

2 When the video output is 720p or 480p (NTSC) or 576p (PAL), the same footage at 30fps (NTSC) or 25fps (PAL) will repeatedly be output twice for each frame to the monitor compatibles to the frame rate output of 60fps (NTSC) and 50fps (PAL).

License

AVC patent portfolio license

THIS PRODUCT IS LICENSED UNDER THE AVC PATENT PORTFOLIO LICENSE FOR THE PERSONAL AND NONCOMMERCIAL USE OF A CONSUMER TO (i) ENCODE VIDEO IN COMPLIANCE WITH THE AVC STANDARD ("AVC VIDEO") AND/OR (ii) DECODE AVC VIDEO THAT WAS ENCODED BY A CONSUMER ENGAGED IN A PERSONAL AND NON-COMMERCIAL ACTIVITY AND/OR WAS OBTAINED FROM A VIDEO PROVIDER LICENSED TO PROVIDE AVC VIDEO. NO LICENSE IS GRANTED OR SHALL BE IMPLIED FOR ANY OTHER USE. ADDITIONAL INFORMATION MAY BE OBTAINED FROM MPEG LA, L.L.C. SEE [HTTP://WWW.MPEGLA.COM](http://www.mpegla.com)

FUJIFILM

FUJIFILM Corporation 7-3, Akasaka 9-chome, Minato-ku, Tokyo 107-0052, Japan

<https://global.fujifilm.com/>

HDMI[®]
HIGH-DEFINITION MULTIMEDIA INTERFACE