

FUJIFILM

Surveillance Camera

FUJIFILM SX801

V2.1

Owner's Manual: IP Mode

FUJIFILM Corporation

BL00005225-201

Table of Contents

Safety Precautions	1
For Your Safety	1
⚠ WARNINGS	1
⚠ CAUTIONS	1
General Precautions	1
NOTICES	2
Caution:	2
FCC Warning:	2
For Customers In Canada	2
About the Icons	2
Disposal of Electrical and Electronic Equipment in Private Households In the European Union, Norway, Iceland and Liechtenstein:	3
Precautions for Use	4
Operating Environment	4
Installation	4
Use	4
Network Connections	4
Introduction	5
Parts of the Camera	5
The Control Panel	5
Installation and Connection	6
Installation	6
Screw Hole Specifications	6
Connection Schematic	7
Operating Mode Selection: DIP Switches	7
Connecting to a Computer	8
Viewing and Recording the Live Feed	9
Dedicated Camera Configuration Software	9
Launching the Software	10
The “LIVE VIEW” Tab	11
The “PLAYBACK” Tab	12

The "CONFIGURATION" Tab	13
CAMERA SETTING	14
FOCUS.....	14
FOCUS AREA	14
AF SENSITIVITY.....	14
IRIS.....	14
SHUTTER SPEED.....	14
GAIN.....	14
DAY/NIGHT	15
EXTERNAL TRIGGER	15
IR WAVELENGTH.....	16
IMAGE STABILIZATION.....	16
IMAGE QUALITY SETTING.....	17
OPTICAL FILTER(DAY)	17
OPTICAL FILTER(NIGHT).....	17
WDR	17
BACKLIGHT CORRECTION.....	17
HEAT HAZE REDUCTION.....	17
FOG REDUCTION	17
NOISE REDUCTION.....	17
DIGITAL ZOOM	18
DIGITAL ZOOM RATIO	18
USE SETTING.....	18
BRIGHTNESS.....	18
CONTRAST.....	18
SATURATION.....	18
SHARPNESS.....	18
WHITE BALANCE.....	18
SYSTEM	19
MODEL NAME.....	19
SERIAL NO.....	19
FW VER. (BODY).....	19
FW VER. (IP)	19
APPLICATION VER.....	19
TIME ZONE	19
PORT NUMBER.....	19
NTP SERVER ADDRESS	19
CHECKING INTERVAL	19
PRIORITY OF TIME SETTING	19
IN-CAMERA TIME SETTING	20
ABOUT DEVICE	20
PTZ SETTING.....	21
RS485 BAUD RATE.....	21
RS485 ID	21
RS485 TERMINATION.....	21
PTZ POSITION INQUIRY	21
PELCO CMD INTERVAL.....	21
SYSTEM MAINTENANCE	22
REBOOT.....	22
RESET SETTINGS	22
IMPORT CONFIGURATION FILE.....	22
EXPORT TO CONFIGURATION FILE	22
FIRMWARE UPDATE	22
COPY LOG DATA	22
SECURITY	23
RTSP AUTHENTICATION	23
RTSP AUTHENTICATION ALGORITHM.....	23

Table of Contents



NETWORK SETTING	24
IPv4 ADDRESS	24
IPv4 SUBNET MASK.....	24
IPv4 DEFAULT GATEWAY	24
MAC ADDRESS.....	24
IPv4 ADDRESS	24
PORT	25
RTSP PORT.....	25
IMAGE DATA SETTING	26
SAVE FILES IN PC.....	26
microSD	26
SAVE FROM LIVE VIEW	26
SAVE FROM PLAYBACK.....	26
WHEN microSD CARD IS FULL.....	26
FORMAT microSD CARD.....	26
VIDEO	27
VIDEO SYSTEM.....	27
ASPECT FOR VIDEO.....	27
STREAM TYPE (Main).....	27
STREAM TYPE (Sub 1)	27
STREAM TYPE (Sub 2)	27
BIT RATE	27
VIDEO QUALITY.....	27
FRAME RATE	27
ENCODING.....	27
I FRAME INTERVAL.....	27
DISPLAY/OSD SETTING	28
CAMERA NAME (ID) DISPLAY	28
TITLE DISPLAY.....	28
DATE DISPLAY.....	28
DAY OF WEEK DISPLAY	28
CAMERA NAME (ID).....	28
TITLE.....	28
TIME DISPLAY	28
DATE DISPLAY FORMAT.....	28
ONVIF	29
ONVIF	29
USER NAME	29
PASSWORD	29
言語/LANG.	30
言語/LANG.....	30

Troubleshooting	31
Defaults	32
CAMERA SETTING.....	32
IMAGE QUALITY SETTING.....	32
SYSTEM.....	32
PTZ SETTING.....	32
SECURITY.....	32
NETWORK SETTING.....	32
VIDEO.....	32
DISPLAY/OSD SETTING.....	32
ONVIF.....	32
言語/LANG.....	32
Specifications	33

Safety Precautions

For Your Safety

This section lists important precautions that must be followed to ensure safe and correct use of the product. Read them before using the product and observe them during use.

The  **WARNING** and  **CAUTION** indications in this document indicate the following:

 **WARNINGS** Failure to observe warnings could result in death or serious injury.

 **CAUTIONS** Failure to observe cautions could result in injury or property damage.

WARNINGS

- Take all steps necessary to prevent water entering the product. Failure to observe this precaution could result in fire or electric shock. Should water find its way in, disconnect the power source immediately.
- Be sure the product is installed securely. Serious accidents could result should the product fall from a height.
- When working in high places, work with a partner or partners, use a safety line, and take all other precautions necessary to ensure safety. Slipping, falling, or loss of balance could result in serious accidents.
- When installing the camera in high places, ensure that people below keep their distance. Falling objects could cause serious accidents.
- Ensure that the surface on which the camera is installed is level. Failure to observe this precaution could cause the camera to fall, potentially causing serious accidents.

CAUTIONS

- Keep the product out of direct sunlight.
- Do not turn the product on without first confirming that the power supply is connected correctly.
- The product could cause injury if dropped during transport. Take all precautions necessary to ensure that the product is not dropped.
- Ensure that the voltage of the power supply matches the product's rated voltage. Incorrect voltages could damage the product or result in fire or electric shock.
- When connecting or disconnecting the power cable, hold the plug and not the cable. Damage to the cable could result in fire or electric shock.
- Should you detect any abnormalities such as smoke, unusual noises or smells, or the presence of foreign matter inside the product, disconnect the power supply immediately and contact the original retailer.
- Do not disassemble or modify. Failure to observe this precaution could result in electric shock or product malfunction. Malfunctions or damage resulting from customers disassembling or modifying the product are not covered under warranty.
- Do not aim the camera at the sun. Direct sunlight focused through the lens could damage the product's internal parts.
- Install the camera base down. Installing the camera in other orientations could lead to warping that may impair product performance.

General Precautions

- Use the product only as described in this manual.
- The camera and its accessories are precision devices. Under no circumstances should they be subjected to excessive force.
- Install the camera in a housing or other location where it will not be exposed to rain, wind, dust, or direct sunlight.
- Bringing the camera abruptly from a cold location to a warm and humid environment could cause the lens to fog. Take measures to allow the camera to adapt to the new environment before subjecting it to changes in temperature and humidity.
- Replace the cap if the camera will not be used for an extended period.
- The camera lens has a special anti-reflective coating. As a result, the back of the lens may appear spotted, but this has no effect on performance.

NOTICES

Verification

Model Number: SX801

Trade Mark: Fujifilm

This device complies with Part 15 of the FCC Rules.

Operation is subject to the following two conditions:

(1) This device may not cause harmful interference, and (2) this device must accept any interference received, including interference that may cause undesired operation.

Caution:

This equipment has been tested and found to comply with the limits for a Class A digital device, pursuant to part 15 of the FCC Rules.

These limits are designed to provide reasonable protection against harmful interference when the equipment is operated in a commercial environment.

This equipment generates, uses, and can radiate radio frequency energy and, if not installed and used in accordance with the instruction manual, may cause harmful interference to radio communications. Operation of this equipment in a residential area is likely to cause harmful interference in which case the user will be required to correct the interference at his own expense.

FCC Warning:

To assure continued compliance, follow the attached installation instructions. This includes using the provided power cord and shielded interface cables when connecting to computer or peripheral devices. Also, any unauthorized changes or modifications to this equipment could void the user's authority to operate this device.

For Customers In Canada

CAN ICES-3(A)/NMB-3(A)

WARNING: This equipment is compliant with Class A of CISPR32. In a residential environment this equipment may cause radio interference.

This product complies with the following EU Directives:

- RoHS Directive 2011/65/EU
- EMC Directive 2014/30/EU

Compliance with these directives implies conformity to applicable harmonized European standards (European Norms) which are listed on the EU Declaration of Conformity issued by FUJIFILM Corporation for this product or product family.



This compliance is indicated by the following conformity marking placed on the product:



This marking is valid for non-Telecom products and EU harmonized Telecom products (e.g. Bluetooth).

About the Icons

The symbols on the product represent the following:

	AC
	DC
	Class II equipment (The construction of the product is double-insulated.)

Disposal of Electrical and Electronic Equipment in Private Households In the European Union, Norway, Iceland and Liechtenstein:

This symbol on the product, or in the manual and in the warranty, and/or on its packaging indicates that this product shall not be treated as household waste. Instead it should be taken to an applicable collection point for the recycling of electrical and electronic equipment. By ensuring this product is disposed of correctly, you will help prevent potential negative consequences to the environment and human health, which could otherwise be caused by inappropriate waste handling of this product.



Precautions for Use

Operating Environment

- The camera can be used at temperatures of from –10 to +50 °C (temperatures below freezing are only supported if the power supply is not interrupted) and at humidities of from 10 to 80% (no condensation).
- Prolonged use at high temperatures or humidities could degrade components, shortening product life.
- Do not install the product where it will be exposed to solvents or other chemicals.

Installation

- Do not install LAN or audio cables in close proximity to cables for fluorescent lights or other electrical devices. Failure to observe this precaution could impair sound or image quality. Move the cables if signal quality is affected.
- Using the product in close proximity to powerful electromagnetic fields, such as those produced by television transmitter antennas, electric motors, or transformers, could result in distorted or wavy pictures. Should this occur, use steel cable shielding.
- Use a Category 5 or better shielded twisted pair (STP) LAN cable for LAN connections.
- Plastic cable insulation may sometimes be damaged by crows or other birds. Protect cables using a cable conduit.
- Fix cables in place so that they are not subject to repeated vibration, friction, or tugging. Failure to observe this precaution could cause the cable to break.
- Install the product base down.

Use

- Do not aim the lens directly at the sun or other bright light sources or reflections. Failure to observe this precaution could result in deterioration of the image sensor color filter, affecting picture color.
- Do not subject the product to strong physical shocks or vibration. Failure to observe this precaution could result in product malfunction.
- Clean the product with a soft, dry cloth. Never use chemically-treated cloths or solvents such as benzine (petroleum ether), thinner, or alcohol. Failure to observe this precaution could cause warping or discoloration.
- Do not apply force to the connectors when handling the product. Failure to observe this precaution could result in the product being disconnected or damaged.

Network Connections

- You will need to supply an IP address, subnet mask, and gateway IP address.
- The frame rate may drop if multiple streams are transmitted via unicast.
- When connected to multiple devices, the product will transmit data to all devices at the rate supported by the device with the slowest receiving rate.
- Use the product on a secure network (for example, an in-house LAN).

Introduction

Parts of the Camera

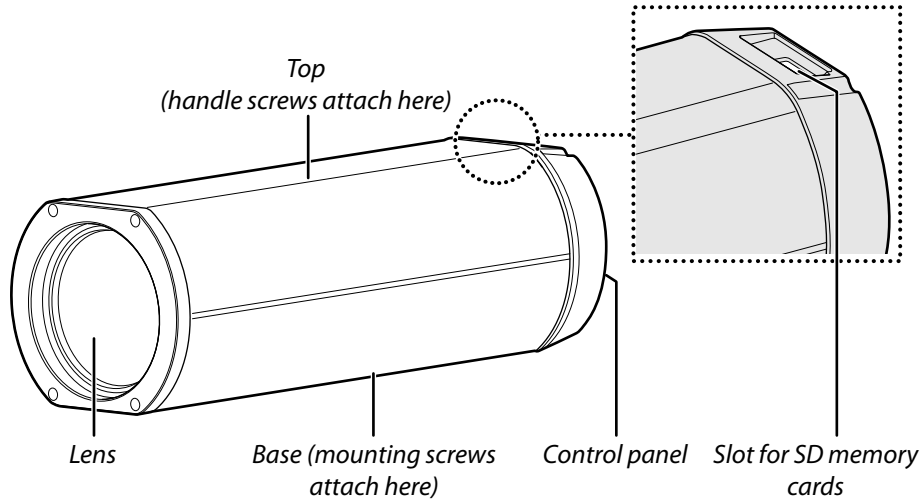

The Control Panel

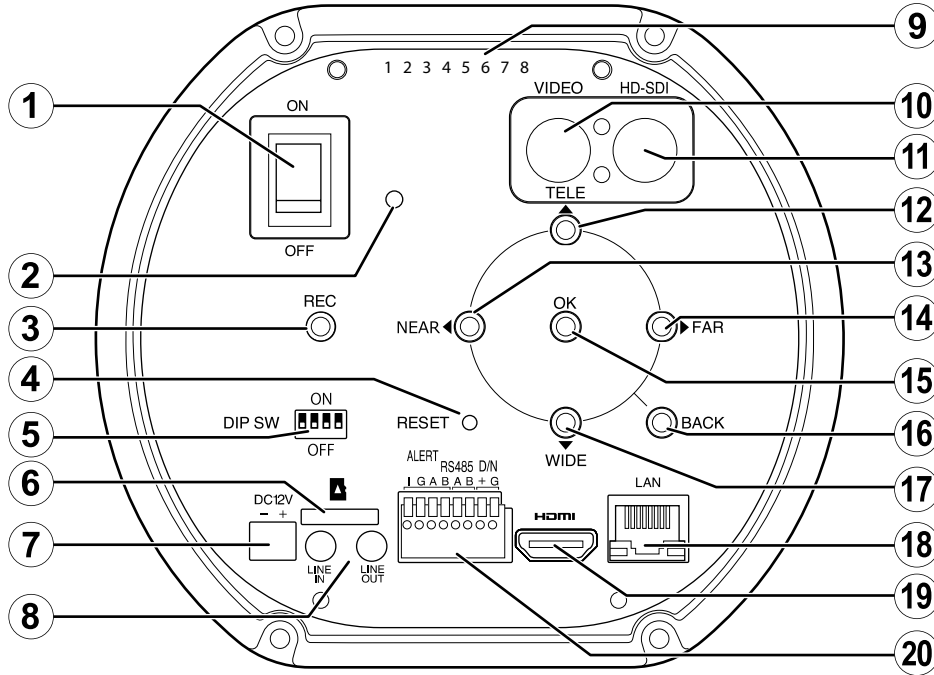

Item	Name
①	Power switch
②	Power lamp
③	REC (record) button
④	RESET button
⑤	DIP switches (4 bits)
⑥	Slot for micro SD memory cards
⑦	Power connector
⑧	Audio input/output connectors
⑨	Serial number
⑩	Video output connector

Item	Name
⑪	HD-SDI output connector
⑫	TELE button
⑬	NEAR button
⑭	FAR button
⑮	OK/MENU button
⑯	BACK button
⑰	WIDE button
⑱	LAN connector
⑲	HDMI connector
⑳	8-pin connector

Installation and Connection

Installation

Use the screw holes on the base to secure the camera to a mount or other surface.

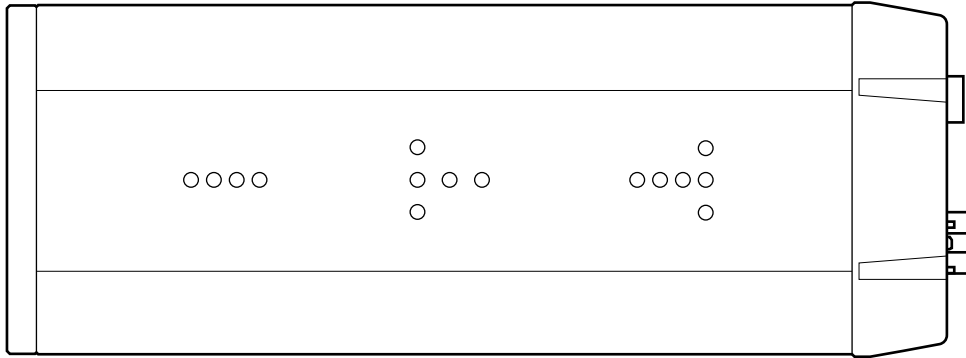

WARNING

Attach the product securely to a surface that can safely bear the combined weight of the camera and associated hardware. Do not mount the camera in unstable locations or locations subject to frequent vibration or attach it to weak materials such as drywall, ALC (autoclaved lightweight concrete), concrete blocks, or plywood. Injury could result should the product fall from its mounting.

CAUTIONS

- Use ¼", UNC 20 thread screws with a thread engagement length of 6.5 to 10 mm.
- Install the camera base down.

A handle can be attached using the screws on top of the camera.

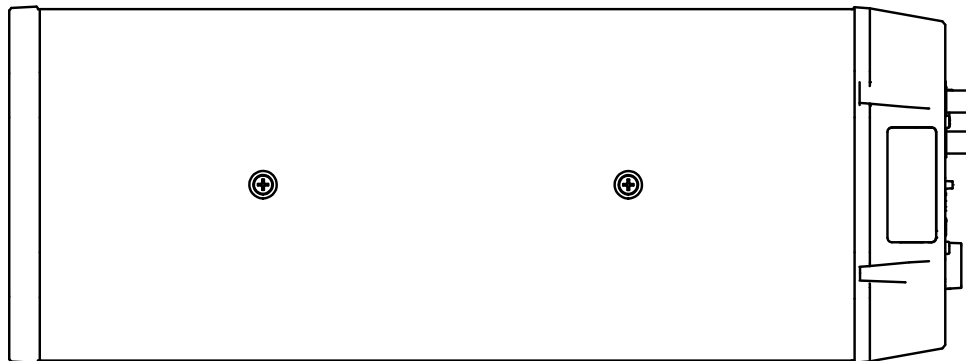

CAUTIONS

- Use M4 screws with a thread engagement length of at least 4 mm and a protrusion of no more than 6 mm.
- Do not use the screw holes on top of the camera for any other purpose.

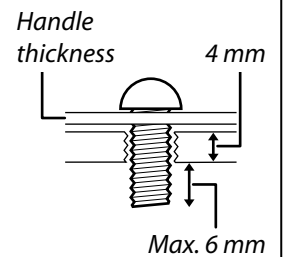

Screw Hole Specifications

The specifications for the screw holes on the top and base of the camera are as follows:

	Type	Quantity	Depth	Tightening torque
Top	M4	2	Pass through (threaded depth 4 mm)	80–100 N·cm
Base	¼", UNC 20 thread	15	10 mm	240–300 N·cm

Connection Schematic

The schematic below illustrates how the camera can be installed for use in IP mode.

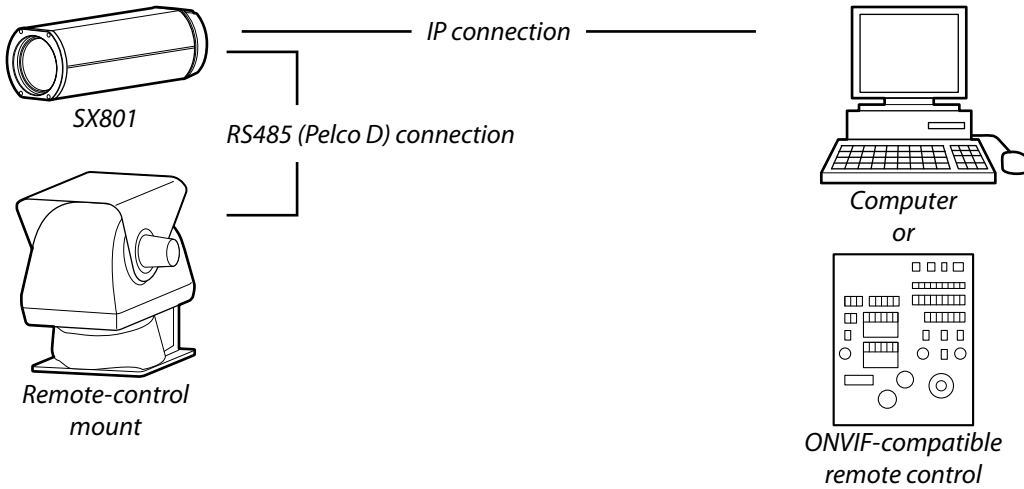

When the camera is connected to a computer in IP mode, camera settings can be adjusted using dedicated software. An ONVIF application can be used to view the live feed and control the camera.

Operating Mode Selection: DIP Switches

Use the DIP switches to select the operating mode.

Operating mode	DIP switch			
	①	②	③	④
IP	OFF	ON	OFF	OFF
RS485	ON	OFF	OFF	OFF
Stand-alone	ON	ON	OFF	OFF

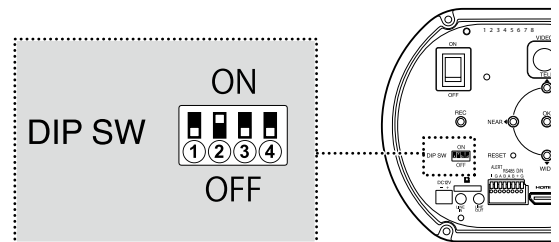

Connecting to a Computer

- 1 Connect the supplied plug to the power cable and plug the cable into the camera power connector.

CAUTION Use only DC 12 V power.

TIP Customers must supply their own power cable.

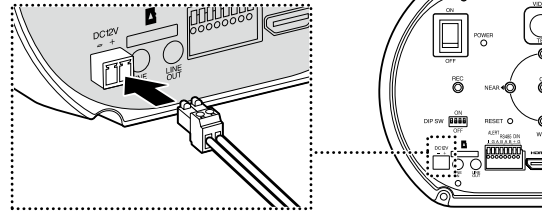

- 2 Use an Ethernet cable to connect the camera to a computer.

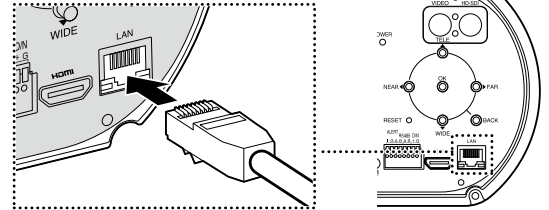

- 3 Select IP mode by setting DIP switch ② to "ON" and DIP switches ①, ③ and ④ to "OFF".

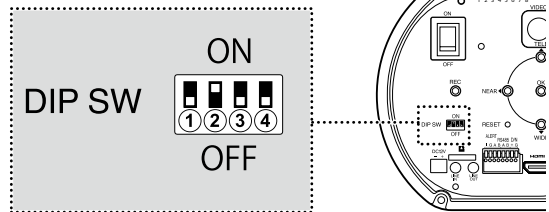

CAUTIONS

- The product cannot be connected directly to telecommunication circuits operated by telecommunications providers (such as mobile or landline telecommunications services or Internet service providers). Connections to the Internet must be made via a router or similar device.
- Use the product on a secure network (for example, an in-house LAN).

TIP

For information on using remote-control mounts or ONVIF-compatible control units, see the documentation provided with the device.

Viewing and Recording the Live Feed

Dedicated Camera Configuration Software

The camera's live feed can be viewed and recorded using dedicated camera configuration software.

Supported operating systems	Windows 10
-----------------------------	------------

To connect to the SX801, you will need to assign it an appropriate IP address. The default IP address and subnet mask assigned to the camera at shipment are as follows:

IP address	192.168.1.10
Subnet mask	255.255.255.0

Extract the software from the zip archive "SX801_Video_Manager.zip" after downloading it to the desktop or another location on the computer.



The software is available for download from the following URL:

https://www.fujifilm.com/support/surveillance_camera/



SX801_Video_Manager.zip

Launching the Software

- 1 Turn on the camera and computer.
- 2 Double-click "SX801 Video Manager.exe" to launch the software.
A login dialog will be displayed.
- 3 Enter a user name, password, and client IP address.
The default IP address is "192.168.1.10".

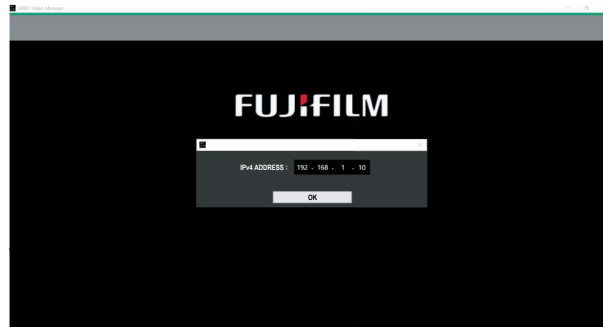

First launch: Enter a new user name and password as desired.

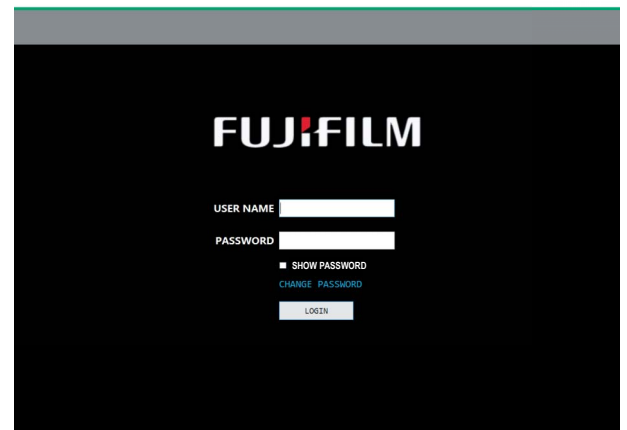

Subsequent launches: Enter the existing user name and password.

- Enter a user name and password, both of which can be from 8 to 15 characters long. Take all steps necessary to protect the password.
- After 10 failed attempts, password entry will lock. The camera must then be re-initialized in stand-alone mode as described below.

Note that this deletes all existing accounts.



TIPS

- ① Turn the camera off.
- ② Select stand-alone mode using the DIP switches on the rear control panel (page 7).
- ③ Turn the camera on.
- ④ Press and hold the **OK/MENU** button on the rear control panel for 3 seconds to display the menus.
- ⑤ Select **IP ADDRESS SETTINGS RESET** in the setup menu.
- ⑥ Turn the camera off and return to Step 3 of "Connecting to a Computer" (page 8).

Note: For more information, see the *Owner's Manual: Stand-Alone Mode*.

- 4 Click **LOGIN**.
The live feed from the camera will be displayed.

The "LIVE VIEW" Tab

The live feed from the camera is displayed in the "LIVE VIEW" tab.

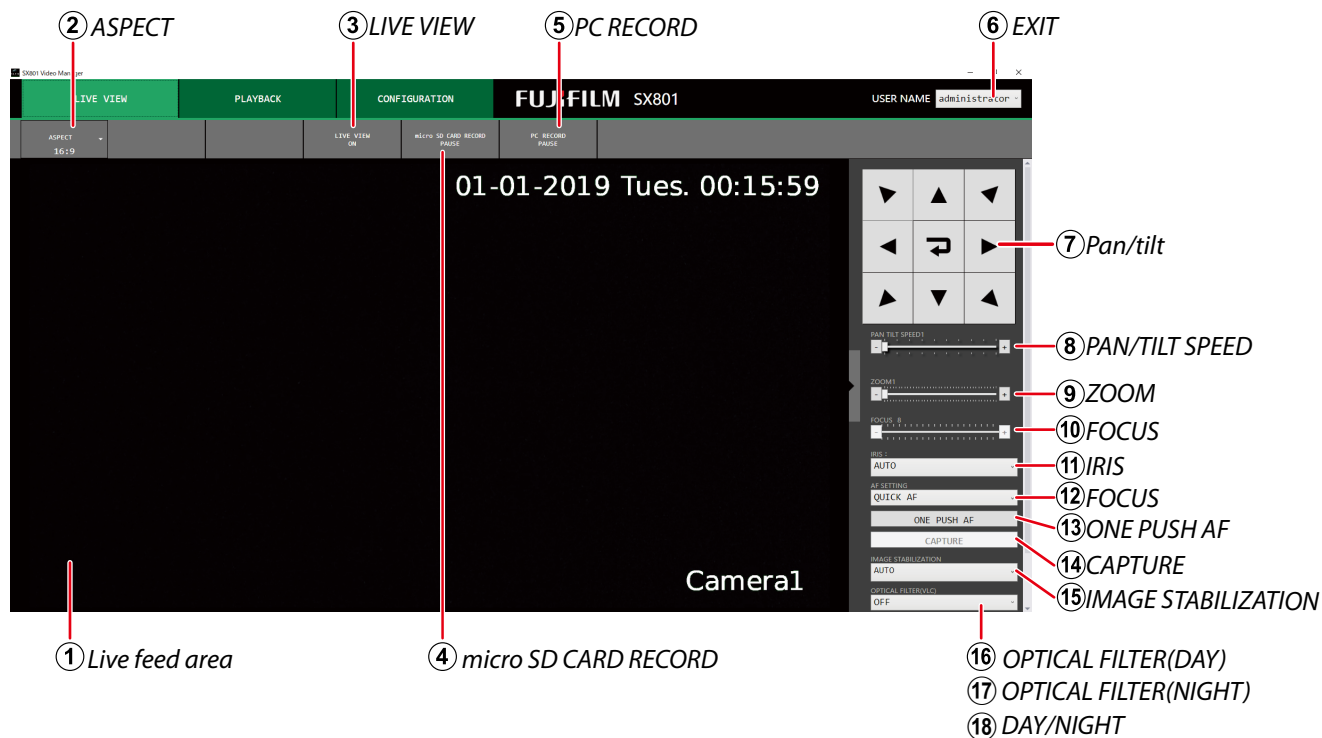

Category	Description
① Live feed area	View the live feed from the camera.
② ASPECT	Choose the display aspect ratio.
③ LIVE VIEW	Turn the live feed display on or off.
④ micro SD CARD RECORD	Record the live feed to the micro SD memory card.
⑤ PC RECORD	Record the live feed to the computer.
⑥ EXIT	Exit the application via the pull-down menu.
⑦ Pan/tilt	Use the arrows to pan or tilt. Press the center button to return the default position.
⑧ PAN/TILT SPEED	Adjust the pan/tilt speed.
⑨ ZOOM	Zoom in or out.
⑩ FOCUS	Adjust focus. Available only when MF is selected for FOCUS.
⑪ IRIS	Adjust aperture.
⑫ FOCUS	Choose from CONTINUOUS AF, QUICK AF, and MF.
⑬ ONE PUSH AF	Click to focus.
⑭ CAPTURE	Save the current frame as a still image.
⑮ IMAGE STABILIZATION	Choose from Auto, OIS, EIS, and OFF.
⑯ OPTICAL FILTER(DAY)	Choose the daylight mode optical filter from IRC and VLC.
⑰ OPTICAL FILTER(NIGHT)	Choose the night mode optical filter from CLEAR and VLC.
⑱ DAY/NIGHT	Choose from AUTO, SCHEDULED, AUTO & SCHEDULED, DAY, and NIGHT modes.

The "PLAYBACK" Tab

Recorded footage can be viewed in the "PLAYBACK" tab.

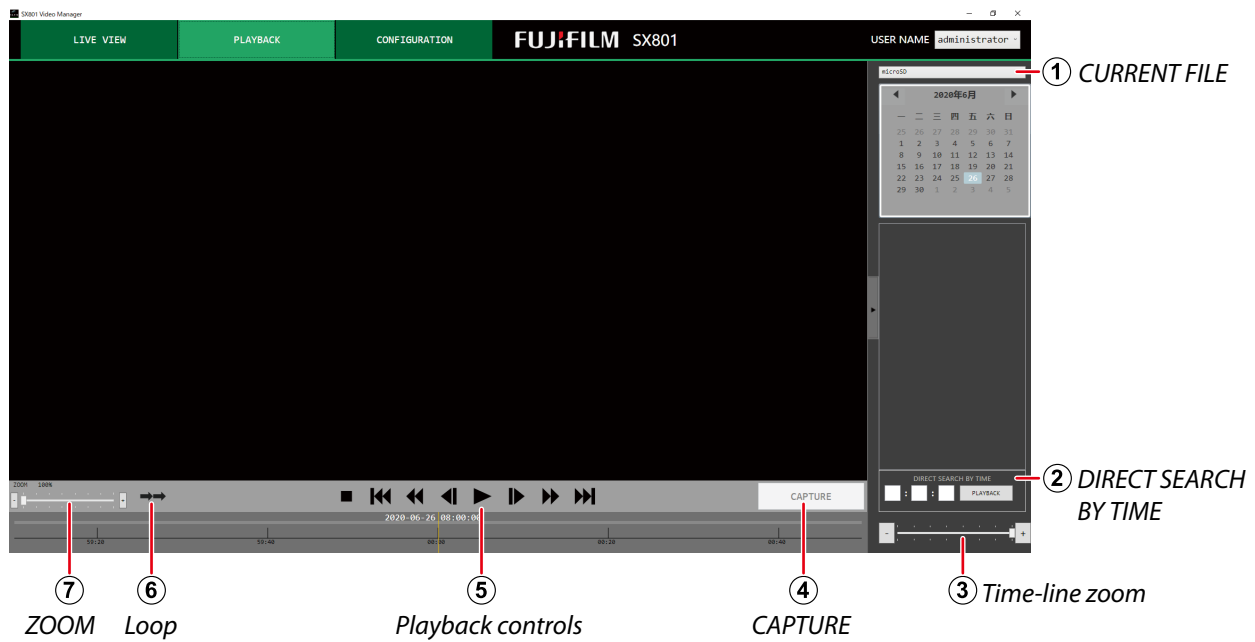

Category	Description
① CURRENT FILE	Choose footage for playback.
② DIRECT SEARCH BY TIME	Search for and view footage by time of recording.
③ Time-line zoom	Zoom the time-line in or out.
④ CAPTURE	Save the current frame as a still image.
⑤ Playback controls	Perform basic playback operations.
⑥ Loop	Choose from CONTINUOUS and REPEAT (loop) playback.
⑦ ZOOM	Zoom the playback display in or out.

The "CONFIGURATION" Tab

Adjust camera settings.



Choosing a category (1) displays the associated settings (2). The live feed from the camera is shown in the live feed area (3).

Category	Description
CAMERA SETTING	Adjust basic camera settings.
IMAGE QUALITY SETTING	Adjust image quality settings.
SYSTEM	View the firmware version and other information or set the camera clock and adjust other system-related settings.
PTZ SETTING	Adjust settings for remote-control mounts.
SYSTEM MAINTENANCE	Restart the camera, update camera firmware, and perform other forms of system maintenance.
SECURITY	Adjust network security settings.
NETWORK SETTING	Adjust basic network settings.
PORT	Choose the RTSP port.
IMAGE DATA SETTING	Choose a destination for video footage and stills or format micro SD memory cards.
VIDEO	Adjust video system and streaming settings.
DISPLAY/OSD SETTING	Adjust display settings, including those for the display of menus.
ONVIF	Adjust ONVIF settings.
言語/LANG.	Choose a language for camera menus and displays.

CAUTION Do not insert or remove memory cards while the camera is on. Failure to observe this precaution could corrupt image files or damage the memory card.

CAMERA SETTING

Adjust basic camera settings.

FOCUS

Choose how the camera focuses when autofocus is enabled via ONVIF.

Options		
CONTINUOUS AF	QUICK AF	MF

FOCUS AREA

Choose how the camera selects the focus area.

Option	Description
CENTER	The camera focuses on the subject at the center of the frame.
AREA	The frame is divided into a three-by-three grid for focus-area selection.

AF SENSITIVITY

Choose how long the focus system will continue to track the current subject after a new subject enters the focus area at a different distance from the camera. The higher the value, the longer the camera will wait before switching subjects. This option applies when **CONTINUOUS AF** is selected for **FOCUS**.

IRIS

Choose the aperture value (iris). See "Specifications" (page 33) for supported values.

SHUTTER SPEED

Choose the shutter speed.

Option	Description
AUTO	The camera adjusts shutter speed automatically. You can choose the minimum shutter speed.
MANUAL	Choose the shutter speed manually.

GAIN

Adjust image brightness.

Option	Description
MANUAL	Choose a value for gain.
AGC	The camera adjusts gain automatically to brighten the image when lighting is poor.
HYPER-AGC	Choose for automatic gain control adapted to low light conditions.

DAY/NIGHT

In day/night mode, the camera records in color when the subject is brightly lit and in black-and-white when the subject is poorly lit. This option is available when **OFF** is selected for **EXTERNAL TRIGGER**.

Option	Description
AUTO	The camera selects day or night mode automatically according to lighting conditions. You can choose the lighting conditions that trigger the switch when AUTO is selected: <ul style="list-style-type: none"> • DAY to NIGHT THRESHOLD: Choose the brightness threshold that triggers the switch from day to night (0–255). • NIGHT to DAY THRESHOLD: Choose the brightness threshold that triggers the switch from night to day (0–255). • SWITCHING SENSITIVITY: Choose how long (0–60 S) the camera waits to switch modes once the brightness threshold is crossed.
SCHEDULED	The camera switches to day or night mode at a selected time. <ul style="list-style-type: none"> • DAY START TIME: Choose a time from 00:00 to 23:59. • NIGHT START TIME: Choose a time from 00:00 to 23:59.
AUTO & SCHEDULED	Choose a light trigger and time for switching between day and night modes. <ul style="list-style-type: none"> • DAY to NIGHT THRESHOLD: Choose the brightness threshold that triggers the switch from day to night (0–255). • NIGHT to DAY THRESHOLD: Choose the brightness threshold that triggers the switch from night to day (0–255). • SWITCHING SENSITIVITY: Choose how long (0–60 S) the camera waits to switch modes once the brightness threshold is crossed. • DAY START TIME: Choose a time from 00:00 to 23:59. • NIGHT START TIME: Choose a time from 00:00 to 23:59.
DAY	The camera operates in day mode at all times.
NIGHT	The camera operates in night mode at all times.

 **TIP** The **CAMERA SETTING > DAY/NIGHT, EXTERNAL TRIGGER, and IR WAVELENGTH** and the **IMAGE QUALITY SETTING > OPTICAL FILTER(DAY) and OPTICAL FILTER(NIGHT)** preferences are linked. For more information, see "Lighting Triggers" (page 16).

EXTERNAL TRIGGER

Choose whether day/night selection is performed in response to an external trigger.

Option	Description
ON(VLC)	Applies a VLC (Visible Light Cut) filter to the external trigger. The optical filters selected for day/night are disabled.
ON(CLEAR)	Replaces the filter with clear glass. The optical filters selected for day/night are disabled.
OFF	The camera does not respond to the external trigger.

 **TIP** The **CAMERA SETTING > DAY/NIGHT, EXTERNAL TRIGGER, and IR WAVELENGTH** and the **IMAGE QUALITY SETTING > OPTICAL FILTER(DAY) and OPTICAL FILTER(NIGHT)** preferences are linked. For more information, see "Lighting Triggers" (page 16).

IR WAVELENGTH

Match the IR wavelength to the infrared light source used. See "Specifications" (page 33) for supported values.

 **TIP** The **CAMERA SETTING > DAY/NIGHT, EXTERNAL TRIGGER**, and **IR WAVELENGTH** and the **IMAGE QUALITY SETTING > OPTICAL FILTER(DAY)** and **OPTICAL FILTER(NIGHT)** preferences are linked. For more information, see "Lighting Triggers" (page 16).

IMAGE STABILIZATION

Choose an image stabilization option adapted to the scene.

Option	Description
AUTO	The camera chooses the type of image stabilization best suited to the scene.
OIS	Reduce the effects of camera shake using optical image stabilization.
EIS	Reduce the effects of camera shake using electronic image stabilization.
OFF	Image stabilization disabled.

Lighting Triggers

Day/night selection can be configured in any of the following three ways:

Configuration	Description	Configured using	
		Menu item	Option
① Auto	Day/night selection is performed automatically according to a schedule and/or lighting conditions.	CAMERA SETTING > DAY/NIGHT	AUTO, SCHEDULED, or AUTO & SCHEDULED
② Manual	Day/night selection is performed manually.		DAY or NIGHT
③ External trigger	Day/night selection is performed in response to input from an external trigger.	CAMERA SETTING > EXTERNAL TRIGGER	ON(VLC)*, ON(CLEAR)*, or OFF

* The optical filters chosen for day/night do not apply if a signal is received from the external trigger when **ON(VLC)** or **ON(CLEAR)** is selected for **EXTERNAL TRIGGER**. If no signal is received or if **OFF** is selected, the optical filter will function as shown in the following table.

The following table shows relation between the filter selected for day/night, image color, and wavelength:

Option	Filter	Image color	CONFIGURATION > CAMERA SETTING > IR WAVELENGTH	
			Status	Supported wavelengths
DAY	IRC	Color	Disabled	Visible light only
	VLC			808 nm only
NIGHT	CLEAR	Black and white	Enabled	950 nm, 940 nm, 850 nm, 808 nm, visible light
	VLC			

IMAGE QUALITY SETTING

Adjust image quality settings.

OPTICAL FILTER(DAY)

Choose an optical filter for day mode.

Option	Description
IRC	Enable the IRC filter, blocking infrared light and recording only visible-light footage.
VLC	Enable the VLC filter, blocking visible light and recording only infrared footage.

 **TIP** The CAMERA SETTING > DAY/NIGHT, EXTERNAL TRIGGER, and IR WAVELENGTH and the IMAGE QUALITY SETTING > OPTICAL FILTER(DAY) and OPTICAL FILTER(NIGHT) preferences are linked. For more information, see "Lighting Triggers" (page 16).

OPTICAL FILTER(NIGHT)

Choose an optical filter for night mode.

Option	Description
CLEAR	Record footage in both infrared and visible light.
VLC	Enable the VLC filter, blocking visible light and recording only infrared footage.

 **TIP** The CAMERA SETTING > DAY/NIGHT, EXTERNAL TRIGGER, and IR WAVELENGTH and the IMAGE QUALITY SETTING > OPTICAL FILTER(DAY) and OPTICAL FILTER(NIGHT) preferences are linked. For more information, see "Lighting Triggers" (page 16).

WDR

Use with high-contrast subjects to reveal details "washed out" in the highlights and lost in the shadows. Choose higher values for high-contrast subjects.

BACKLIGHT CORRECTION

Reduce loss of detail in the shadowed areas of backlit subjects. The higher the value, the greater the effect.

HEAT HAZE REDUCTION

Reduce the wavering effect of heat haze, making the image clearer overall. The higher the value, the greater the effect.

FOG REDUCTION

Make images where the subject is obscured by fog more vivid and easier to see. The higher the value, the greater the effect.

NOISE REDUCTION

Reduce the effects of noise for a smoother picture. The higher the value, the greater the effect.

DIGITAL ZOOM

Choose the digital zoom type.

Option	Description
CONTINUOUS	The camera zooms smoothly from maximum optical zoom to the zoom ratio selected for DIGITAL ZOOM RATIO .
EXTENDED	The camera zooms instantaneously from the current zoom position (whatever it may be) to the zoom ratio selected for DIGITAL ZOOM RATIO .
OFF	Digital zoom disabled.

DIGITAL ZOOM RATIO

Choose the zoom factor for digital zoom.

Options			
2.00	1.75	1.50	1.25

USE SETTING

Choose a shooting preset.

Option	Description
SURVEILLANCE	Emphasize outlines.
MOVIE PRODUCTION	Choose for accurate color reproduction when shooting non-surveillance footage at social gatherings or other events.

BRIGHTNESS

Adjust brightness. The further the slider is to the right, the greater the effect.

CONTRAST

Adjust contrast. The further the slider is to the right, the greater the effect.

SATURATION

Adjust color saturation. The further the slider is to the right, the greater the effect.

SHARPNESS

Make outlines more or less sharply defined. The further the slider is to the right, the greater the effect.

WHITE BALANCE

Match white balance to the light source (for example, sunlight or artificial lighting).

Option	Description
AUTO	The camera adjusts white balance automatically.
AUTO WHITE PRIORITY	The camera sets white balance to a high level.
CUSTOM 1/CUSTOM 2	Measure a value for white balance using a piece of paper or other white reference object.
FINE	For subjects lit by direct sunlight.
SHADE	For subjects in the shade or under overcast skies.
COLOR TEMPERATURE	Choose a color temperature (3000K, 5000K, or 9000K).

 **TIP** After choosing an option for white balance, you can adjust white balance shift.

SYSTEM

View the firmware version and other information. You can also set the camera clock and adjust other system-related settings.

MODEL NAME

View the camera model name.

SERIAL NO.

View the product serial number.

FW VER. (BODY)

View the camera firmware version.

FW VER. (IP)

View the version of the IP connection firmware.

APPLICATION VER.

View the application version.

TIME ZONE

Choose a time zone.

PORT NUMBER

Choose the NTP server port.

NTP SERVER ADDRESS

Enter the IP address for the NTP (Network Time Protocol) server.

CHECKING INTERVAL

Choose how often the camera checks the NTP server port.

PRIORITY OF TIME SETTING

Choose whether the time display matches the camera's internal clock (**DEVICE**) or the time reported by the NTP server (**NTP**).

Option	Description
DEVICE	The display shows the time reported by the camera's internal clock.
NTP	The display shows the time reported by the NTP server.

The "CONFIGURATION" Tab

IN-CAMERA TIME SETTING

Set the camera clock.

ABOUT DEVICE

View OSS information.

PTZ SETTING

Adjust settings for remote-control mounts.

RS485 BAUD RATE

Choose the baud rate for data transmitted via RS485.

Options					
115200bps	38400bps	19200bps	9600bps	4800bps	2400bps

RS485 ID

Choose the RS485 ID (1–31).

RS485 TERMINATION

Select **ON** to enable the RS485 termination resistor.

PTZ POSITION INQUIRY

Choose whether the camera queries remote-control mounts for pan and tilt positions.

 **CAUTION** Select **ON** when using the camera with remote-control mounts that support position queries.

PELCO CMD INTERVAL

Choose the interval at which the camera sends Pelco commands to remote-control mounts (10–300 msec).

SYSTEM MAINTENANCE

Restart the camera, update camera firmware, and perform other forms of system maintenance.

REBOOT

Select **OK** to restart the camera.

RESET SETTINGS

Select **OK** to restore camera settings to their default values. Items in the following menu are not affected:

- NETWORK SETTING

IMPORT CONFIGURATION FILE

Import settings from a camera settings file. Click **BROWSE** and choose a settings file created using **EXPORT TO CONFIGURATION FILE**.

EXPORT TO CONFIGURATION FILE

Export camera settings. Click **OK** to download the settings folder.

FIRMWARE UPDATE

Update the camera firmware. Click **BROWSE** and select the file containing the new firmware version to begin the update.

COPY LOG DATA

Save a copy of camera logs. Click **BROWSE**, choose a destination, and click **OK** to save the logs.

SECURITY

Adjust network security settings.

RTSP AUTHENTICATION

Choose an RTSP authentication method (**DISABLE**, **BASIC**, or **DIGEST**).

RTSP AUTHENTICATION ALGORITHM

Choose an algorithm for **DIGEST** authentication (**MD5** or **SHA256**).

NETWORK SETTING

Adjust basic network settings.

IPv4 ADDRESS

Change the camera's IPv4 address.

IPv4 SUBNET MASK

Change the camera's IPv4 subnet mask.

IPv4 DEFAULT GATEWAY

Change the camera's default IPv4 gateway.

MAC ADDRESS

View the camera's MAC address.

IPv4 ADDRESS

Choose how the IPv4 address is assigned.

Option	Description
MANUAL	Choose the IPv4 address manually.
AUTO (DHCP)	The IPv4 address is assigned automatically.

 **TIP** Click **SAVE** to save changes.

PORT

Adjust port settings.

RTSP PORT

Choose the RTSP port.

IMAGE DATA SETTING

Adjust image data settings.

SAVE FILES IN PC

View the destination for footage saved to the computer. To choose a different folder, click **BROWSE**.

Option	Description
ON	Footage is saved to the computer.
OFF	Footage is not saved to the computer.

microSD

Choose whether to save footage to micro SD memory cards.

Option	Description
ON	Footage is saved to the micro SD memory card.
OFF	Footage is not saved to micro SD memory cards.

SAVE FROM LIVE VIEW

Choose the destination for stills captured from the live feed.

SAVE FROM PLAYBACK

View the destination for stills captured during playback. To choose a different folder, click **BROWSE**.

WHEN microSD CARD IS FULL

Choose whether the camera overwrites existing data when micro SD memory cards are full.

Option	Description
OVERWRITE	When the micro SD memory card is full, the camera overwrites existing files to make room for new data.
NOT OVERWRITE	The camera stops recording data when the micro SD memory card is full.

FORMAT microSD CARD

Select **OK** to format the micro SD memory card. Any existing data on the card will be deleted.

VIDEO

Adjust video settings.

VIDEO SYSTEM

Choose the standard (NTSC (60 Hz) or PAL (50 Hz)) used for video output from the camera.

ASPECT FOR VIDEO

Choose how video is displayed on monitors with an aspect ratio that does not match the selected format.

Option	Description
SIDE CUT	The image is cropped to fit the display.
LETTERBOX	The image is displayed at its original aspect ratio with black bars above and below.
SQUEEZE	Video with an aspect ratio of 16:9 is reformatted to fit displays with a 4:3 aspect ratio.

STREAM TYPE (Main)

Choose from three video resolution options for the primary stream.

STREAM TYPE (Sub 1)

Choose from two video resolution options for the secondary stream, or choose **OFF** to disable the secondary stream altogether.

STREAM TYPE (Sub 2)

Choose a video resolution option for the tertiary stream, or choose **OFF** to disable the tertiary stream altogether.

BIT RATE

Choose whether streaming video is encoded at a **FIXED** or **VARIABLE** bit rate. Note that this option is available only when H.264 encoding is selected.

VIDEO QUALITY

Choose the output quality for streaming video (**HIGH**, **STANDARD**, or **LOW**). Note that this option is available only when H.264 encoding is selected.

FRAME RATE

Choose the frame rate for streaming video from values between 1 and 30 fps.

ENCODING

Choose an encoding for streaming video.

I FRAME INTERVAL

Choose the I-Frame interval for streaming video.

DISPLAY/OSD SETTING

Adjust display settings.

CAMERA NAME (ID) DISPLAY

Choose whether the camera name is displayed.

TITLE DISPLAY

View, hide, and position the title display.

DATE DISPLAY

View, hide, and position the date display.

DAY OF WEEK DISPLAY

View or hide the day-of-the-week display.

CAMERA NAME (ID)

Name the camera. Symbols and alphanumeric characters can be used.

TITLE

Enter a title. Symbols and alphanumeric characters can be used.

TIME DISPLAY

Choose whether times are displayed using a 12- or 24-hour clock.

DATE DISPLAY FORMAT

Choose the date display format.

 **TIP** Click **SAVE** to save changes.

ONVIF

Adjust ONVIF settings.

ONVIF

Option	Description
ON	Enable ONVIF.
OFF	Disable ONVIF.

USER NAME

Enter an ONVIF user name.

PASSWORD

Enter an ONVIF password.

 **TIP** Click **SAVE** to save changes.

言語/LANG.

Choose a language for camera menus and displays.

言語/LANG.

Choose a language.

Troubleshooting

Should the product fail to function as expected, consult the table below. If you are unable to find a solution here, contact your local Fujifilm distributor.

Problem	Solution
No video, or the image in the video is dark.	<ul style="list-style-type: none">• The camera is off: Check that the cables are correctly connected, the power lamp is lit, and the correct voltage is being supplied to the lens.• The cables are not correctly connected: Check that the cables are correctly connected.• The lens cap is on: Remove the lens cap.• The iris is stopped down to the minimum aperture: Select maximum aperture.• Shutter speed requires adjustment: Select an appropriate value for shutter speed.
The image in the video is “washed out”.	<ul style="list-style-type: none">• Camera white balance, gain, shutter speed, or other settings require adjustment: Confirm that settings are adjusted appropriately.• Aperture requires adjustment: Adjust aperture appropriately.
The image in the video is out of focus. Spots appear in the video.	<ul style="list-style-type: none">• The lens is dirty: Clean the lens.

Defaults

Selecting OK for SYSTEM MAINTENANCE > RESET SETTINGS restores settings to the following default values:

CAMERA SETTING

Option	Default
FOCUS	QUICK AF
FOCUS AREA	CENTER
AF SENSITIVITY	1
IRIS	AUTO
SHUTTER SPEED	AUTO (1/30)
GAIN	AGC
	AUTO
DAY/NIGHT	<ul style="list-style-type: none"> • DAY to NIGHT THRESHOLD: 70 • NIGHT to DAY THRESHOLD: 130 • SWITCHING SENSITIVITY: 7 S
EXTERNAL TRIGGER	OFF
IR WAVELENGTH	VISIBLE LIGHT
IMAGE STABILIZATION	AUTO

IMAGE QUALITY SETTING

Option	Default
OPTICAL FILTER(DAY)	IRC
OPTICAL FILTER(NIGHT)	CLEAR
WDR	OFF
BACKLIGHT CORRECTION	OFF
HEAT HAZE REDUCTION	OFF
FOG REDUCTION	OFF
NOISE REDUCTION	2
DIGITAL ZOOM	OFF
DIGITAL ZOOM RATIO	1.25
USE SETTING	SURVEILLANCE
BRIGHTNESS	50
CONTRAST	50
SATURATION	50
SHARPNESS	80
WHITE BALANCE	AUTO

SYSTEM

Option	Default
TIME ZONE	GMT+09:00

PTZ SETTING

Option	Default
RS485 BAUD RATE	9600 bps
RS485 ID	7
RS485 TERMINATION	ON

SECURITY

Option	Default
RTSP AUTHENTICATION	BASIC
RTSP AUTHENTICATION ALGORITHM	MD5

NETWORK SETTING

Option	Default
IPv4 ADDRESS	192.168.1.10
IPv4 SUBNET MASK	255.255.255.0
IPv4 DEFAULT GATEWAY	192.168.1.254

VIDEO

Option	Default
VIDEO SYSTEM	NTSC (60 Hz)
ASPECT FOR VIDEO	SIDE CUT
STREAM TYPE (Main)	1080p
STREAM TYPE (Sub 1)	OFF
STREAM TYPE (Sub 2)	OFF
BIT RATE	FIXED
VIDEO QUALITY	HIGH
FRAME RATE	15 fps
ENCODING	H.264
I FRAME INTERVAL	1S

DISPLAY/OSD SETTING

Option	Default
CAMERA NAME (ID) DISPLAY	BOTTOM RIGHT
TITLE DISPLAY	BOTTOM RIGHT
DATE DISPLAY	BOTTOM RIGHT
DAY OF WEEK DISPLAY	ON
TIME DISPLAY	24H
DATE DISPLAY FORMAT	MM-DD-YYYY

ONVIF

Option	Default
ONVIF	ON

言語/LANG.

Option	Default
言語/LANG.	ENGLISH

Specifications

Model	FUJIFILM SX801
Focal length	20–800 mm
Optical zoom	40×
Digital zoom	1.25×, 1.5×, 1.75×, 2×
Iris range	f/4–f/16
Minimum object distance (M.O.D.)*	10 m at focal lengths of 20–400 mm 20 m at focal lengths of 400–800 mm
Image sensor	CMOS sensor
Video	<ul style="list-style-type: none"> • File format <ul style="list-style-type: none"> - Stand-alone: MOV - With ONVIF application software: HWP • Video encoding: H.264 compliant, Motion JPEG
Frame size	1920 × 1080, 1280 × 720, 640 × 480 (NTSC), 768 × 576 (PAL)
Metering	Average
Focus modes	Continuous AF, quick AF, MF
Aperture selection	AUTO, f/4–f/16
Shutter speed	AUTO (with minimum speed selection of 1/8 – 1/125 s), MANUAL (1 – 1/32000 s)
Gain adjustment	MANUAL (ISO 400 – ISO 819200), AGC, HYPER AGC
Day/night	AUTO, SCHEDULED, AUTO & SCHEDULED, DAY, NIGHT
Wavelengths	VISIBLE LIGHT, 950 nm, 940 nm, 850 nm, 808 nm
Image stabilization	AUTO, OIS, EIS, OFF
Wide dynamic range	Selectable (2 levels)
Back light compensation	Selectable (2 levels)
Heat haze reduction	Selectable (3 levels)
Fog reduction	Selectable (3 levels)
Noise reduction	Selectable (3 levels)
Shooting Mode Preset	SURVEILLANCE, MOVIE PRODUCTION
Brightness	Selectable (100 levels)
Contrast	Selectable (100 levels)
Saturation	Selectable (100 levels)
Sharpness	Selectable (100 levels)
White balance	AUTO, AUTO WHITE PRIORITY, CUSTOM 1, CUSTOM 2, FINE, SHADE, COLOR TEMPERATURE (choose a color temperature in degrees Kelvin from 3000K, 5000K, and 9000K)
Image output connectors	HDMI, HD-SDI, composite (BNC)
Video streams	Up to 3 (available in IP connection mode only)
Video output	<ul style="list-style-type: none"> • NTSC: 1080p, 720p, 480p • PAL: 1080p, 720p, 576p
External interface	Ethernet (100BASE-T), RS-485, external trigger (DAY/NIGHT)
Baud rate	152000 bps, 38400 bps, 19200 bps, 9600 bps, 4800 bps, 2400 bps
Internet protocol	ONVIF (port number 8080, RTSP)
RS-485 protocol	Pelco D, P (includes custom commands, IP connection mode supports Pelco D only)
Power source	DC 12 V
Power consumption	Approx. 15 W
Dimensions (W × H × D)	156 mm × 139 mm × 410 mm/6.14 in. × 5.47 in. × 16.14 in.
Weight	Approx. 6.4 kg/14.11 lb
Operating environment	<ul style="list-style-type: none"> • Temperature: –10 °C – +50 °C/+14 °F – +122 °F • Humidity: 10% – 80% (no condensation)
Tilt limit	±45° from level (base down)

* From the foremost part of the forward lens.

FUJIFILM

FUJIFILM Corporation 7-3, Akasaka 9-chome, Minato-ku, Tokyo 107-0052, Japan
<http://www.fujifilm.com/>

HDMI[®]
HIGH DEFINITION MULTIMEDIA INTERFACE